



Audio Video Player



Manufactured under license from Dolby Laboratories. “Dolby”, “MLP Lossless” and the double-D symbol are trademarks of Dolby Laboratories.

HDMI, the HDMI long and High-Definition Multimedia Interface are trademarks or registered trademarks of HDMI Licensing LLC.

This product incorporates copyright protection technology that is protected by U.S. patents and other intellectual property rights. Use of this copyright protection technology must be authorized by Macrovision, and is intended for home and other limited viewing uses only unless otherwise authorized by Macrovision. Reverse engineering or disassembly is prohibited.

“DTS” and “DTS Digital Surround” are registered trademarks of DTS, Inc.

HDCD[®], **HDCD**[®], High Definition Compatible Digital[®] and Microsoft[®] are either registered trademarks or trademarks of Microsoft Corporation, Inc. in the United States and/or other countries. HDCD system manufactured under license from Microsoft Corporation, Inc. This product is covered by one or more of the following: In the USA: 5,479,168, 5,638,074, 5,640,161, 5,808,574, 5,838,274, 5,854,600, 5,864,311, 5,872,531, and in Australia: 669114. Other patents pending.

DivX, DivX Certified, and associated logos are trademarks of DivX, Inc. and are used under licence.

MVP871 Owner's Manual



The lightning flash with arrowhead, within an equilateral triangle, is intended to alert the user to the presence of uninsulated “dangerous voltage” within the product’s enclosure that may be of sufficient magnitude to constitute a risk of electric shock to persons.



AVIS RISQUE DE CHOC ELECTRIQUE - NE PAS OUVRIR.

The exclamation point within an equilateral triangle is intended to alert the user to the presence of important operating and maintenance (servicing) instructions in the literature accompanying the appliance.

WARNING - TO REDUCE RISK OF FIRE OR ELECTRICAL SHOCK, DO NOT EXPOSE THIS EQUIPMENT TO RAIN OR MOISTURE.

NO USER-SERVICEABLE PARTS INSIDE. REFER SERVICING TO QUALIFIED PERSONNEL.

To prevent the risk of electric shock, do not remove cover or back. No user-serviceable parts inside.

CAUTION - Invisible Laser Radiation when open. DO NOT stare into the beam or view directly with optical instruments. Use of controls or adjustments or performance of procedures other than those specified in the Owners Manual may result in Hazardous Radiation Exposure.

**LUOKAN 1 LASERLAITE
KLASS 1 LASER APPARAT**

VAROITUS! Laitteen käyttäminen muulla kuin tassa käyttöohjeessa mainitulla tavalla saattaa altistaa käyttäjän turvallisuusluokan 1 ylittävälle näkymättömälle lasersäteilylle.

VARNING! Om apparaten används på annat sätt än i denna bruksanvisning specificerats, kan användaren utsättas för osynlig laserstrålning, som överskrider gränsen för laserklass 1.

This product incorporates an embedded CLASS 3R Laser (IEC60825-1).

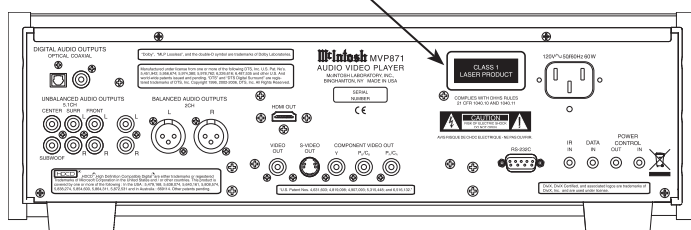
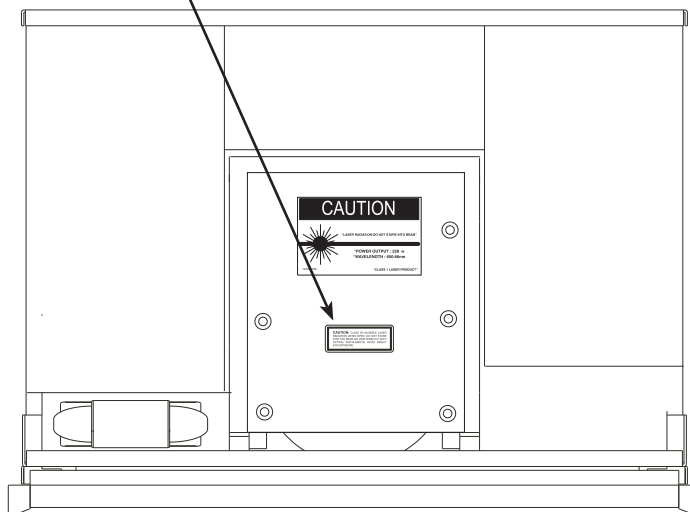
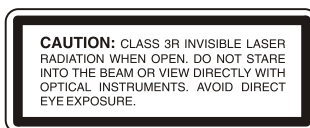

IMPORTANT SAFETY INSTRUCTIONS!

PLEASE READ THEM BEFORE OPERATING THIS EQUIPMENT.

1. Read these instructions.
2. Keep these instructions.
3. Heed all warnings.
4. Follow all instructions.
5. Do not use this apparatus near water.
6. Clean only with a dry cloth.
7. Do not block any ventilation openings. Install in accordance with the manufacturer's instructions.
8. Do not install near any heat sources such as radiators, heat registers, stoves, or other apparatus (including amplifiers) that produce heat.
9. Do not defeat the safety purpose of the polarized or grounding-type plug. A polarized plug has two blades with one wider than the other. A grounding type plug has two blades and a third grounding prong. The wide blade or the third prong are provided for your safety. If the provided plug does not fit into your outlet, consult an electrician for replacement of the obsolete outlet.
10. Protect the power cord from being walked on or pinched particularly at plugs, convenience receptacles, and the point where they exit from the apparatus.
11. Only use attachments/accessories specified by the manufacturer.
12. Use only with the cart, stand, tripod, bracket, or table specified by the manufacturer, or sold with the apparatus. When a cart is used, use caution when moving the cart/apparatus combination to avoid injury from tip-over.
13. Unplug this apparatus during lightning storms or when unused for long periods of time.
14. Refer all servicing to qualified service personnel. Servicing is required when the apparatus has been damaged in any way, such as power-supply cord or plug is damaged, liquid has been spilled or objects have fallen into the apparatus, the apparatus has been exposed to rain or moisture, does not operate normally, or has been dropped.
15. Do not expose this equipment to dripping or splashing and ensure that no objects filled with liquids, such as vases, are placed on the equipment.
16. To completely disconnect this equipment from the a.c. mains, disconnect the power supply cord plug from the a.c. receptacle.
17. The mains plug of the power supply cord shall remain readily operable.
18. Do not expose batteries to excessive heat such as sunshine, fire or the like.





Thank You

Your decision to own this McIntosh MVP871 Audio Video Player ranks you at the very top among discriminating music listeners. You now have “The Best.” The McIntosh dedication to “Quality,” is assurance that you will receive many years of visual and musical enjoyment from this unit. Please take a short time to read the information in this manual. We want you to be as familiar as possible with all the features and functions of your new McIntosh.

Please Take A Moment

The serial number, purchase date and McIntosh Dealer name are important to you for possible insurance claim or future service. The spaces below have been provided for you to record that information:

Serial Number: _____

Purchase Date: _____

Dealer Name: _____

Technical Assistance

If at any time you have questions about your McIntosh product, contact your McIntosh Dealer who is familiar with your McIntosh equipment and any other brands that may be part of your system. If you or your Dealer wish additional help concerning a suspected problem, you can receive technical assistance for all McIntosh products at:

McIntosh Laboratory, Inc.
2 Chambers Street
Binghamton, New York 13903
Phone: 607-723-1545
Fax: 607-724-0549

Customer Service

If it is determined that your McIntosh product is in need of repair, you can return it to your Dealer. You can also return it to the McIntosh Laboratory Service Department. For assistance on factory repair return procedure, contact the McIntosh Service Department at:

McIntosh Laboratory, Inc.
2 Chambers Street
Binghamton, New York 13903
Phone: 607-723-3515
Fax: 607-723-1917

Table of Contents

Safety Instructions	2
Thank You and Please Take a Moment.....	4
Technical Assistance and Customer Service	4
Table of Contents	4
General Information	5
Disc Information.....	6
Connector and Cable Information	6
Introduction.....	7
Performance Features	7
Dimensions	8
Installation	9

Connections:

Rear Panel Connections	10
How to Connect Control, Analog and Digital Audio	11
How to Connect Video and AC Power	12

Front Panel Features:

Front Panel Indicators and Push-buttons	14
Front Panel Information Display.....	15

Remote Control:

Remote Control Push-buttons.....	16
How to Operate by Remote Control	17

Setup:

How to Operate the Setup Mode	18
Default Settings	19
Language Setup	20
Digital Interface Setup.....	21
Video Setup.....	26
Audio Setup	30
Set the Ratings	35
Other Setup	37

Operation:

How to Operate.....	40
Video Settings and Adjustments.....	47

Additional Information:

Specifications.....	50
Packing Instruction.....	51

General Information

1. For additional connection information, refer to the owner’s manual(s) for any component(s) connected to the MVP871 Audio Video Player.
2. If the MVP871 will be connected to a TV/Monitor using the Component Video connections, please refer to the Setup Section entitled “Component Video Out” on page 27 of this Owner’s Manual for important information.
3. The Super Audio Compact Discs (SACD) Audio Signals are converted internally from Digital to Analog.
4. A PCM version of the decoded MP3 Signal is available at the Digital Audio Outputs.
5. The MVP871 has built-in 192kHz 24-Bit DACs (Digital to Analog Converter) to allow playing of DVDs recorded with a higher bit and sample rate, by using the Analog Audio Outputs.
6. Some Multichannel DVD, DVD-Video, DVD-Audio and Super Audio Compact Discs might contain Low Frequency Audio Signals (below 80Hz) in the Center and/or Surround Channels. If the Loudspeakers in your sound system are not capable of reproducing those Low Frequencies, distortion and/or possible damage to the Loudspeakers may occur. Refer to page 22. For additional information, consult with your Dealer or refer to the Owner’s Manual for your Loudspeakers.
7. The DVD-Audio and Super Audio Compact Discs Audio Signals are converted internally from Digital to Analog. The Six Channel Analog Signals are available at the UNBALANCED AUDIO OUTPUTS 5.1CH.
8. The MVP871 basic transport functions may also be controlled by using the Remote Control that comes with a McIntosh Control Center or Preamplifier. McIntosh Keypads can also be used to remotely control the basic transport functions of the MVP871. Remote Controls of certain McIntosh Control Centers or Preamplifiers also have additional Push-buttons including Direction Keys, Select, Title, Display and Menu that perform the same functions as the supplied MVP871 Remote Control. The labeling of Push-buttons on some McIntosh Remote Controls and Keypads are different from the supplied MVP871 Remote Control. Refer to the following listing and illustrations:

<i>MVP871 Remote Control</i>	<i>Control Center/Preamp/Keypad</i>
<i>Play</i>	<i>Play</i>
<i>Next</i>	<i>Next</i>
<i>Back</i>	<i>Back</i>
<i>Stop</i>	<i>Stop</i>
<i>Review</i>	<i>Review</i>
<i>0-9</i>	<i>0-9</i>
<i>Pause</i>	<i>E</i>
<i>+10</i>	<i>Review</i>

McIntosh Remote Controls for A/V Control Centers and Preamplifiers

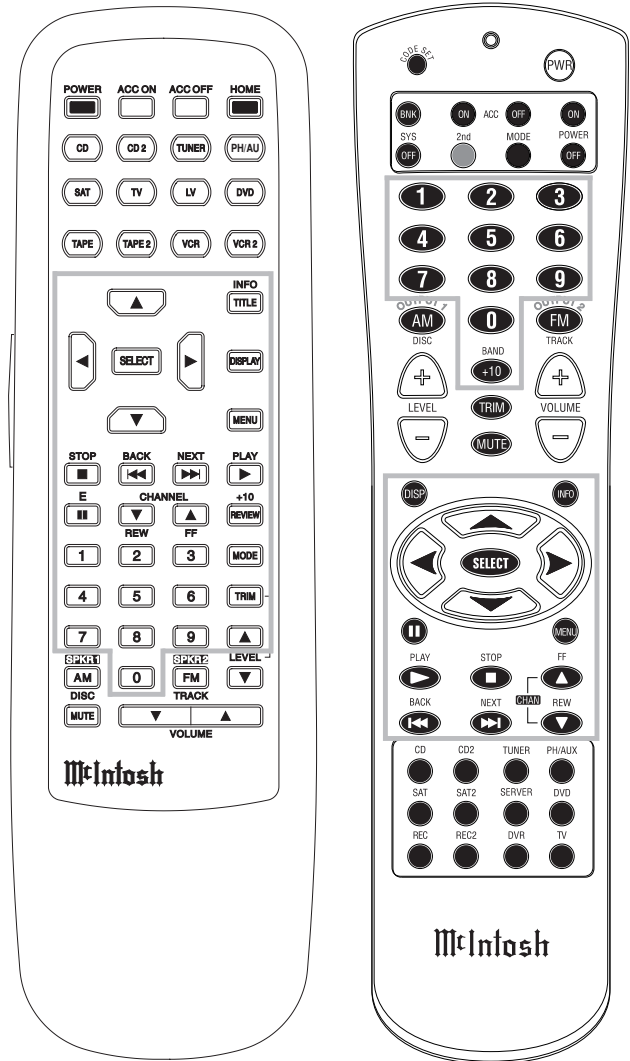

Disc Information

1. Compact Discs that are not round (e.g. Novelty discs with octagonal or heart shapes) will not play properly in the MVP871 and should not be tried, as possible damage may occur.
2. The MVP871 Audio Video Player is designed to play all standard CD Audio Discs that conform to the Official Compact Disc Standards which is indicated by the Symbol .
3. The MVP871 will play most of the following discs, however some recorded discs may not be able to play due to the condition of the recording:
 - Super Audio CD (SACD), HDCD, CD-R, CD-RW, Video CD, Picture CD (Kodak), Fujicolor CD, WMA(Windows), DVD-Audio, DVD-Video, DVD-R, DVD+R, DVD-RW, DVD+RW and DivX.
4. The MVP871 plays DivX Videos including DivX 3, 4, 5 and 6 as well as purchased or rented DivX Movies.
5. CD Audio Discs recorded in the MP3 Format will playback on the MVP871 except discs that contain multi-session recordings.
6. The CD audio side of the Dual Disc does not meet the Compact Disc Digital Audio specifications found in the industry "Redbook"; the MVP871 may not read the CD side of a Dual Disc.
7. Several of the DVD, DVD-Audio and SACD performance features available on the MVP871 are active only if the Disc includes the supporting encoded information.
8. DVD-Video Discs are designed to only play in certain region(s) of the world. A region may be a single country or a group of countries. Usually on the back cover of the DVD-Video Disc container is a Globe Symbol with "Number(s)" or the word "All" inside it. The MVP871 is designed to play discs for Regions "1" and "All".
9. Certain Dolby Digital and DTS Encoded Discs display their own unique Audio Mode Selection menu, every time the disc is loaded into the player. If you do not make a choice from this menu, the disc will revert to its default Audio Mode when play is started.

Connector and Cable Information

XLR Connectors

Below is the Pin configuration for the XLR Balanced Output Connectors on the MVP871. Refer to the diagram for connection:

- PIN 1: Shield/Ground
- PIN 2: + Output
- PIN 3: - Output

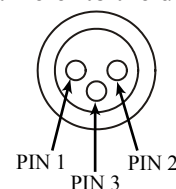

Power Control Connector

The MVP871 Power Control Input/Output Jacks receive/send Power On/Off Signals when connected to other McIntosh Components. A 1/8 inch stereo mini phone plug is used for connection to the Power Control Input/Output on the MVP871.

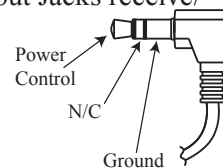

Note: The Data and Power Control Connecting Cable is available from the McIntosh Parts Department:

Data and Power Control Cable Part No. 170-202

Six foot, shielded 2 conductor, with 1/8 inch stereo mini phone plugs on each end.

Data and IR Input Port Connectors

The MVP871 Data In Port receives Remote Control Signals. A 1/8 inch stereo mini phone plug is used for connection. The IR Ports also use a 1/8 inch stereo mini phone plug and allow the connection of other brand IR Receivers to the MVP871.

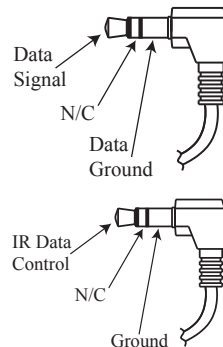

RS232 DB9 Connector Pin Layout

- | | |
|-------------------|--------|
| 1. N/C | 6. N/C |
| 2. Data Out (TXD) | 7. N/C |
| 3. Data In (RXD) | 8. N/C |
| 4. N/C | 9. N/C |
| 5. Gnd. | |

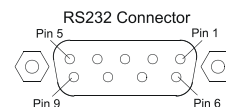

Introduction

The McIntosh MVP871 Audio Video Player offers the latest in audio/video technology, providing state of the art reproduction of digital video and audio program sources. A full complement of performance features allows for the enjoyment of DVDs, SACD, DVD Audio, Audio CDs, special audio and special video formats are all reproduced with flawless realism. The advanced mechanical design of the transport ensures many years of smooth trouble free operation.

Performance Features

• Twin Laser Pickup

The MVP871 incorporates two laser elements, with different wavelengths, that are focused through one lens assembly. This unique design allows reading many different types of Audio and Video Disc Formats.

• Advanced Transport

The MVP871 has a new vibration-resistant Transport with an advanced digital servo for faster, quieter and accurate operation. The DVD Data is read into memory from the disc at twice the normal rate. Likewise CD Audio Data is read into memory at four times the normal rate. The fast read speeds help to insure better disc tracking and error correction processing.

• Video Output with Up Scaling to 1080p

The MVP871's special video processing circuitry scales the native 480i resolution image quality of a DVD disc to 480p, 720p, 1080i or 1080p via the Digital Video Output.

• Multiple Video Outputs

The Component Video Output has switchable Progressive Scan Processing and offers the highest possible analog picture quality available. There are also S-Video and Composite Video Outputs for a variety of applications.

• Advanced Video Circuitry

An advanced technology 12-Bit DAC (Digital Analog Converter) operating at 216MHz with Multi-Directional Diagonal Filter together with Pixel Image Correction, performs video signal processing for enhanced DVD picture quality.

• 24 BIT Burr Brown Audio DAC

The MVP871 has three built-in Burr Brown 2-channel Digital to Analog Converters are capable of sampling rates up to 192kHz with 24 Bits of resolution.

• Balanced Outputs

The MVP871 has Balanced Outputs for the Left and Right Channels when playing a CD. When a Multichannel Disc is playing, the Balanced Left and Right Outputs provide a two channel mix down of the Multichannel Recording.

• Built-in Dolby Digital and DTS Digital Decoders

The MVP871 provides built-in decoding of Dolby Digital and DTS Digital Sound Tracks.

• Digital Audio Outputs

There are Coaxial, Optical and Digital Audio Outputs for external decoding of Dolby Digital, DTS Digital Signals, PCM or MP3 Signals from CDs.

• On Screen Setup and Calibration

Level and Time Delay Adjustments are available for Dolby Digital, DTS Digital, DVD-Audio and SACD Disc Signals and effect the multichannel analog audio outputs.

• Power Control

The Power Control Input connection provides convenient Turn-On/Off of the MVP871 when connected to a McIntosh System with Power Control.

• Remote Control

The Remote Control with illuminated push-buttons, provides control of the MVP871 operating functions. A Data Port Connection to a McIntosh A/V Control Center or Preamplifier allows for convenient system operation using one Remote Control. An External IR Sensor Input allows for remote operation when the MVP871 is located behind closed doors.

• Special Power Supply

A fully regulated Power Supply, with a special R-Core Power Transformer, ensures stable noise free operation even though the power line varies.

• Machined Side Panels

The sides of the MVP871 are machined from thick aluminum panels with a smooth black finish.

• Fiber Optic Solid State Front Panel Illumination

The Illumination of the Glass Front Panel is accomplished by the combination of custom designed Fiber Optic Light Diffusers and extra long life Light Emitting Diodes (LEDs). This provides even Front Panel Illumination and is designed to ensure the pristine beauty of the MVP871 will be retained for many years.



Dimensions

The following dimensions can assist in determining the best location for your MVP871. There is additional information on the next page pertaining to installing the MVP871 into cabinets.

Front View of the MVP871

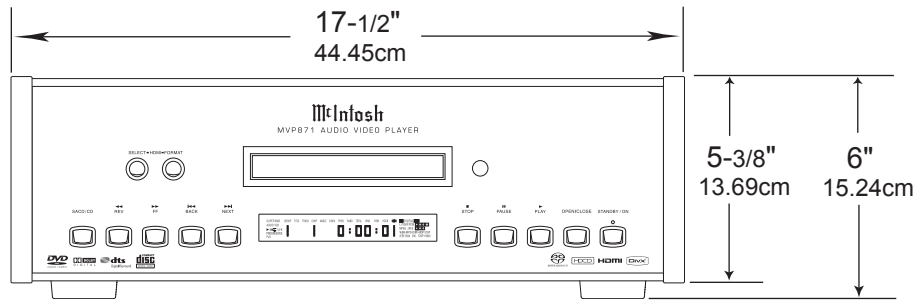

Rear View of the MVP871

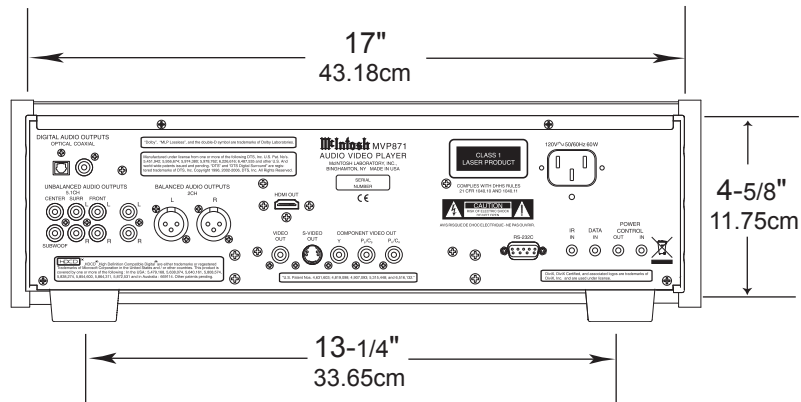

Side View of the MVP871

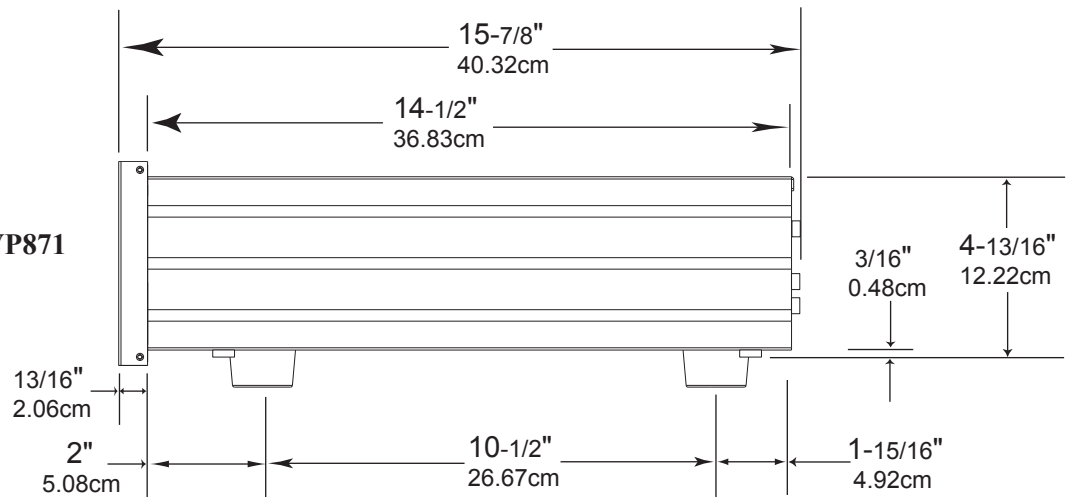

Installation

The MVP871 can be placed upright on a table or shelf, standing on its four feet. It also can be custom installed in a piece of furniture or cabinet of your choice. The four feet may be removed from the bottom of the MVP871 when it is custom installed as outlined below. The four feet together with the mounting screws should be retained for possible future use if the MVP871 is removed from the custom installation and used free standing. The required panel cutout, ventilation cutout and unit dimensions are shown. Always provide adequate ventilation for your MVP871. Cool operation ensures the longest possible operating life for any electronic instrument. Do not install the MVP871 directly above a heat generating component such as a high powered amplifier. If all the components are installed in a single cabinet, a quiet running ventilation fan can be a definite asset in maintaining all the system components at the coolest possible operating temperature.

A custom cabinet installation should provide the following minimum spacing dimensions for cool operation. Allow at least 2 inches (5.08cm) above the top, 2 inches (5.08cm) below the bottom and 1 inch (2.54cm) on each side of the Audio Video Player, so that airflow is not obstructed. **Do not**

block the ventilation holes on the top and bottom cover. Allow 1 inch (2.54 cm) in front of the mounting panel for clearance. When the DVD/CD tray is opened, the panel clearance required in front of mounting panel is 6-3/4 inches (17.2cm). Be sure to cut out a ventilation hole in the mounting shelf according to the dimensions in the drawing.

MVP871 Front Panel Custom Cabinet Cutout

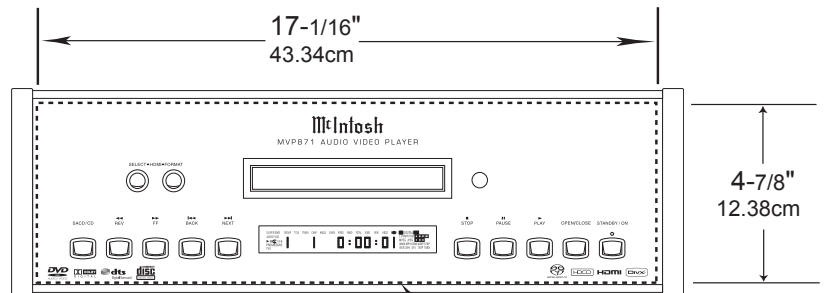

MVP871 Side View in Custom Cabinet

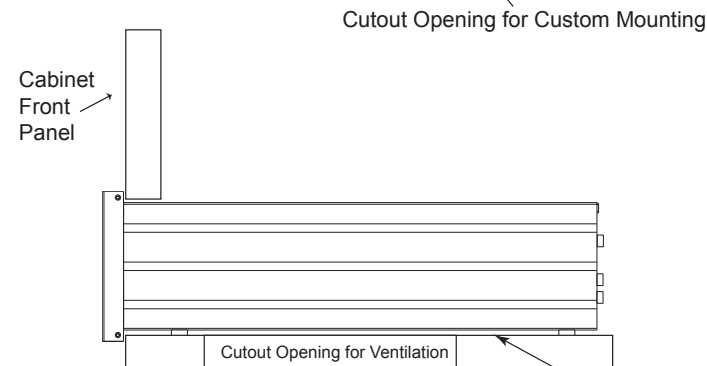

MVP871 Bottom View in Custom Cabinet

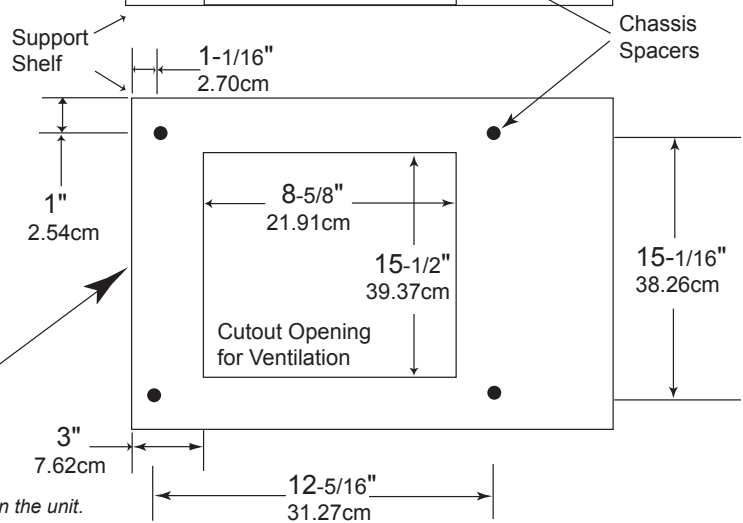

Note: Center the cutout horizontally on the unit. For purposes of clarity, the above illustration is not drawn to scale.



OPTICAL DIGITAL AUDIO OUTPUT sends signals to a Control Center with a D/A Converter or a decoder

HDMI OUT supplies digital video and digital audio signals to an Input of an A/V Control Center or other audio/video component

Y OUTPUT connects to the Y Component Input of the TV/Monitor or other video component.
P_B/C_B OUTPUT connects to the P_B/C_B Component Input of the TV/Monitor or other video component.
P_R/C_R OUTPUT connects to the P_R/C_R Component Input of the TV/Monitor or other video component

COAXIAL DIGITAL AUDIO OUTPUT sends signals to a Control Center with a D/A Converter or a decoder

S-VIDEO OUTPUT supplies video signals to a S Input of an A/V Control Center or other video component

Connect the MVP871 power cord to a live AC outlet. Refer to information on the back panel of your MVP871 to determine the correct voltage for your unit

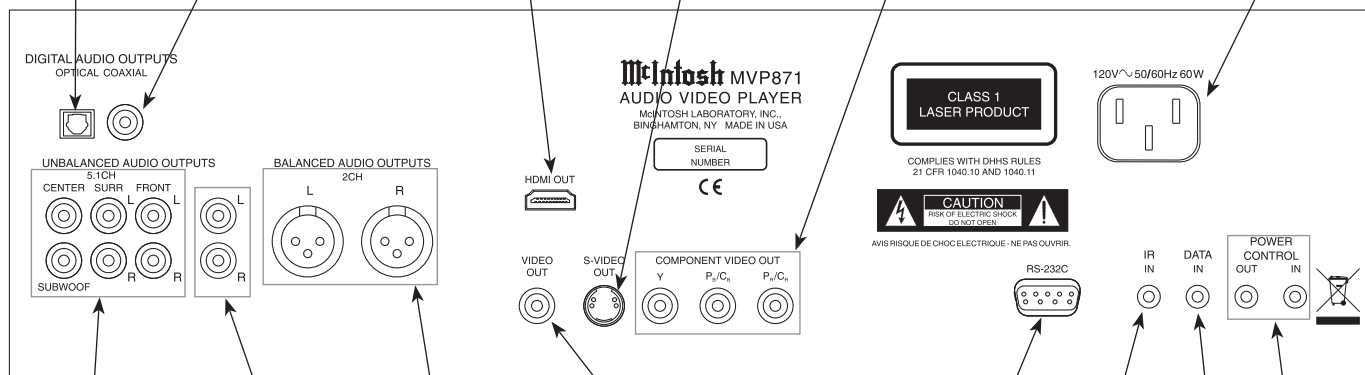

UNBALANCED AUDIO OUTPUTS supply Six Channels of analog audio and connects to the External Input of an A/V Control Center

BALANCED AUDIO OUTPUTS supply two channels of analog audio to connect to Balanced Inputs of other components

VIDEO OUTPUT supplies video signals to connect to a Composite Input of an A/V Control Center or other video component

RS-232C connector for connection to a remote control device

DATA IN receives operating data from a McIntosh Control Center

IR Input for connecting an IR Receiver

POWER CONTROL IN receives turn-on signals from a McIntosh component and **POWER CONTROL OUT** sends turn-on signals on to another McIntosh Component

How to Connect Control, Analog and Digital Audio

1. Connect a Power Control Cable from the MVP871 POWER CONTROL IN to the POWER CONTROL ACC Output jack of a McIntosh A/V Control Center.
2. Connect a Data Cable from the MVP871 DATA IN jack to the DVD DATA jack on the McIntosh A/V Control Center.
3. Connect a Coaxial Cable from the MVP871 DIGITAL AUDIO COAXIAL OUTPUT to the DVD Coaxial DIGITAL INPUT of a McIntosh A/V Control Center.

Note: An optional connecting method is to use an optical cable from the MVP871 DIGITAL AUDIO OPTICAL OUTPUT to the Optical Digital Input of a McIntosh A/V Control Center.

4. Connect Audio Cables from the MVP871 UNBALANCED 2CH AUDIO OUTPUTS to the DVD Inputs on a McIntosh A/V Control Center.
5. Optionally connect Audio Cables from the MVP871 BALANCED 2CH AUDIO OUTPUTS to the Zone A Balanced 1 Inputs on a McIntosh A/V Control Center.
6. Connect Audio Cables from the MVP871 UNBALANCED 5.1CH AUDIO OUTPUTS (all six channels) to the External AUDIO INPUTS on a McIntosh A/V Control Center.

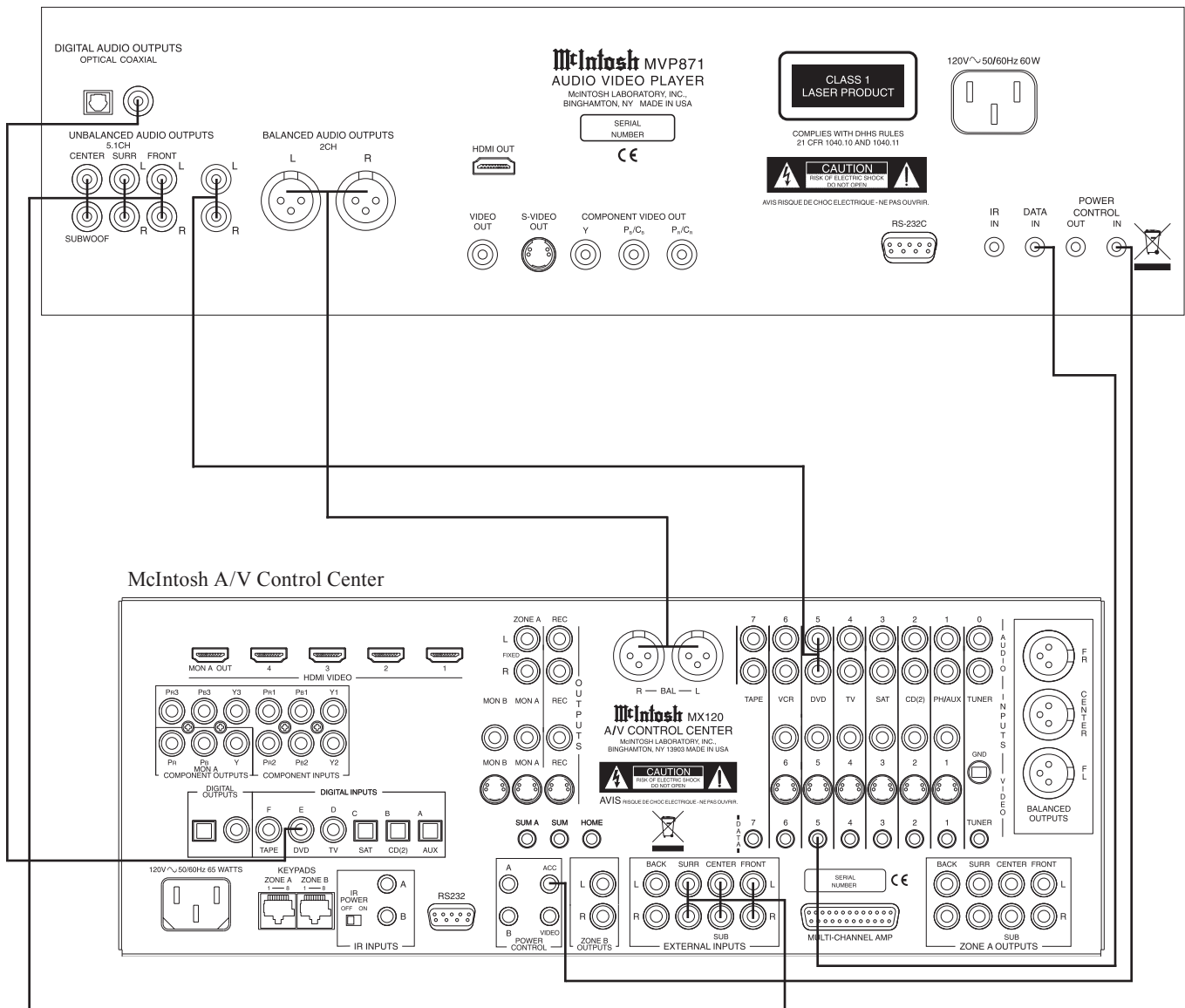



How to Connect Video and AC Power

1. Connect component video cables between the MVP871 and the McIntosh A/V Control Center as follows:

Note: The MVP871's default setting for the Component Video Output Signal is Progressive Scan. Before connecting AC Power to the MVP871, please refer to the Setup Section entitled "Component Video Out" on page 27 of this Owner's Manual for important information.

- A. Connect a cable from the MVP871 Y OUTPUT to the Component Video Input of the McIntosh A/V Control Center.
- B. Connect a cable from the MVP871 P_B/C_B OUTPUT to the P_B Component Video Input of the McIntosh A/V Control Center.
- C. Connect a cable from the MVP871 P_R/C_R OUTPUT to the P_R Component Video Input of the McIntosh A/V Control Center.

2. Connect a cable from the OUT connector on the

MVP871 to the 4 connector on the McIntosh A/V Control Center.

To provide a Video Signal for making a recording, for viewing in Zone B and/or a TV/Monitor without either a Component Video Input and/or Input then connect as follows:

- 3. Optionally, connect a S-Video Cable from the MVP871 S-VIDEO OUT jack to the DVD S-Video input jack on the McIntosh A/V Control Center.
- 4. Optionally, connect a Video Cable from the MVP871 VIDEO OUT jack to the DVD Video input jack on the McIntosh A/V Control Center
- 5. Connect the MVP871 power cord to a live AC outlet.

Note: When AC Power is initially applied to the MVP871 the unit will momentarily switch On and then go into the Standby Mode.

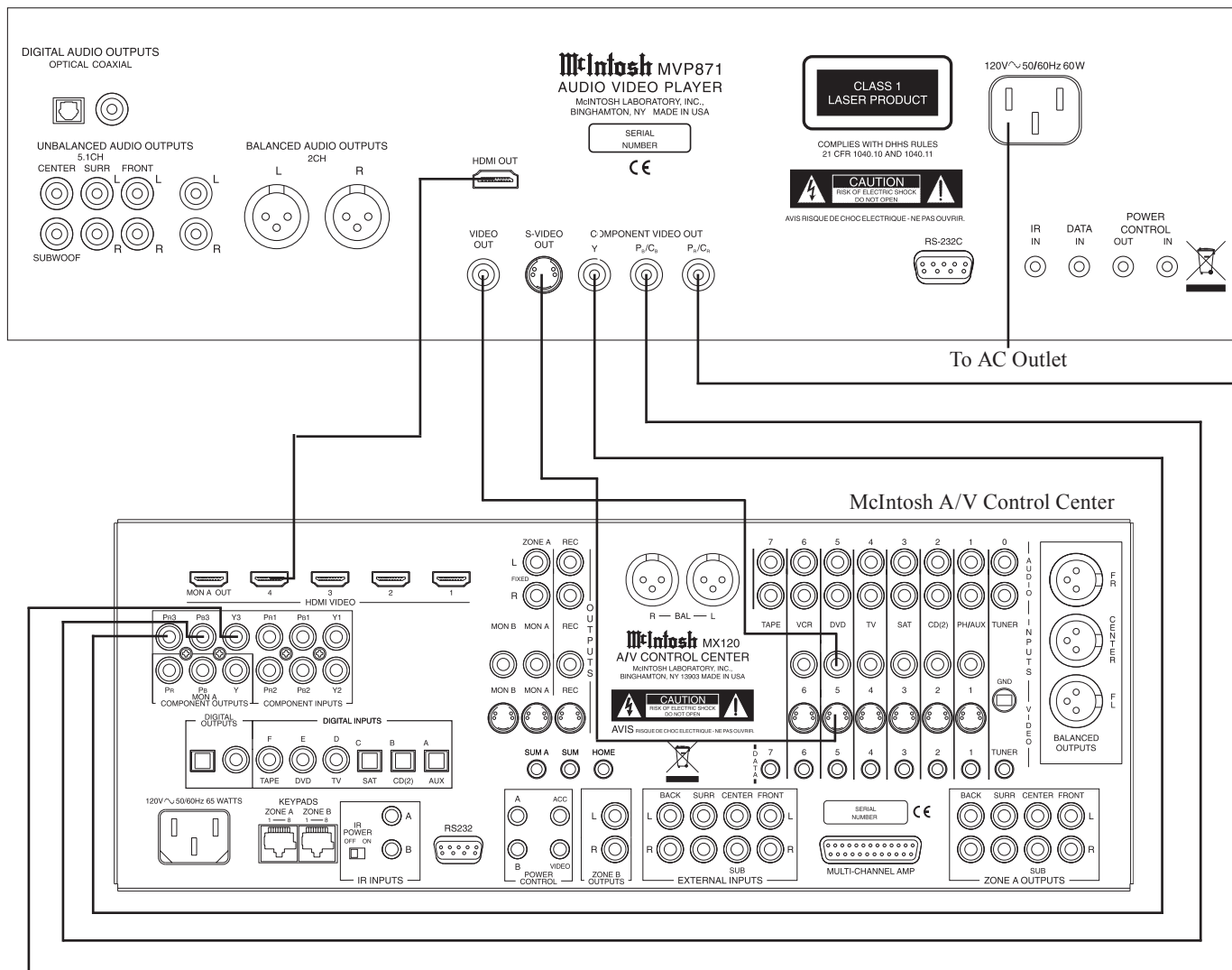

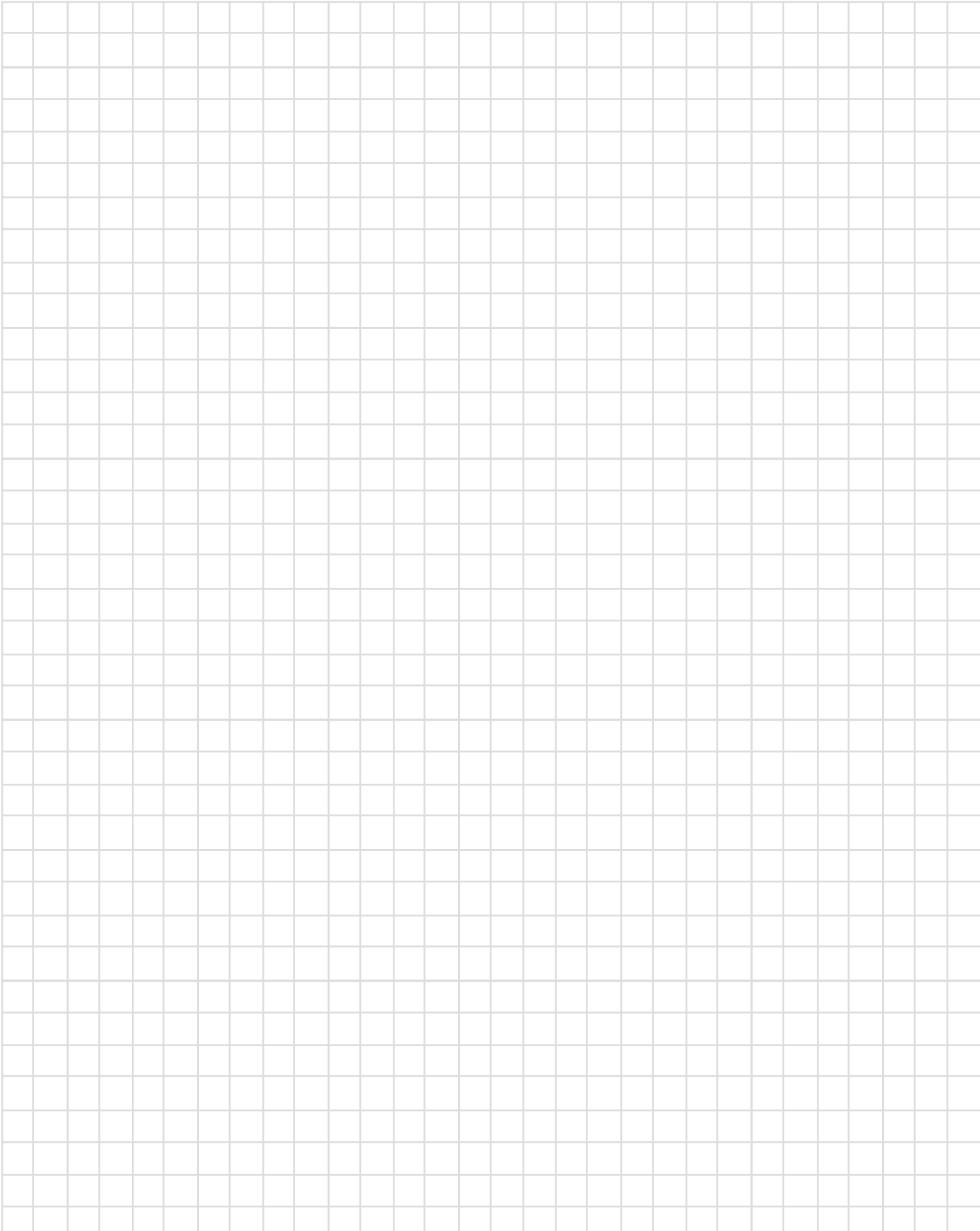

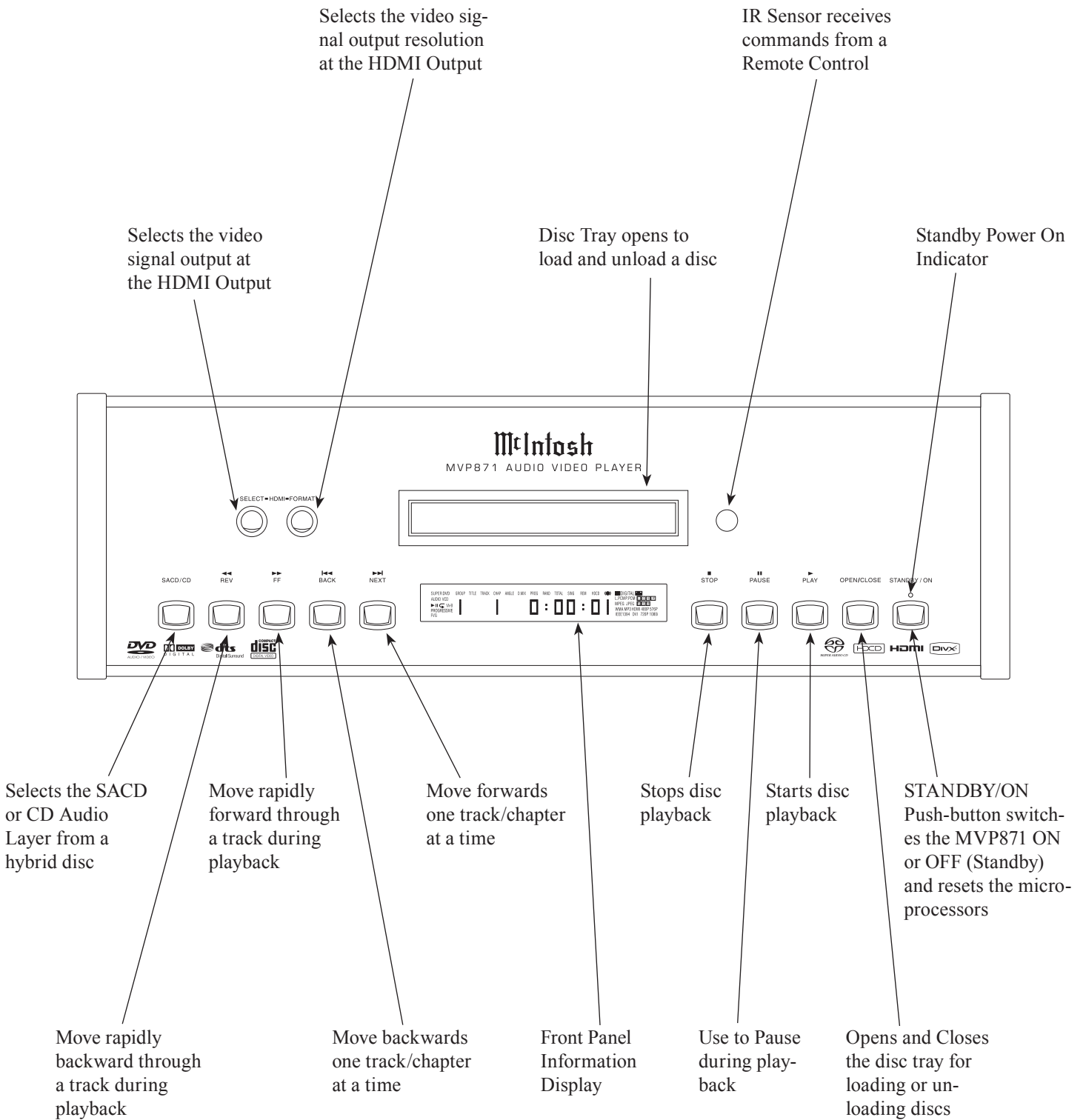

Front Panel Information Display

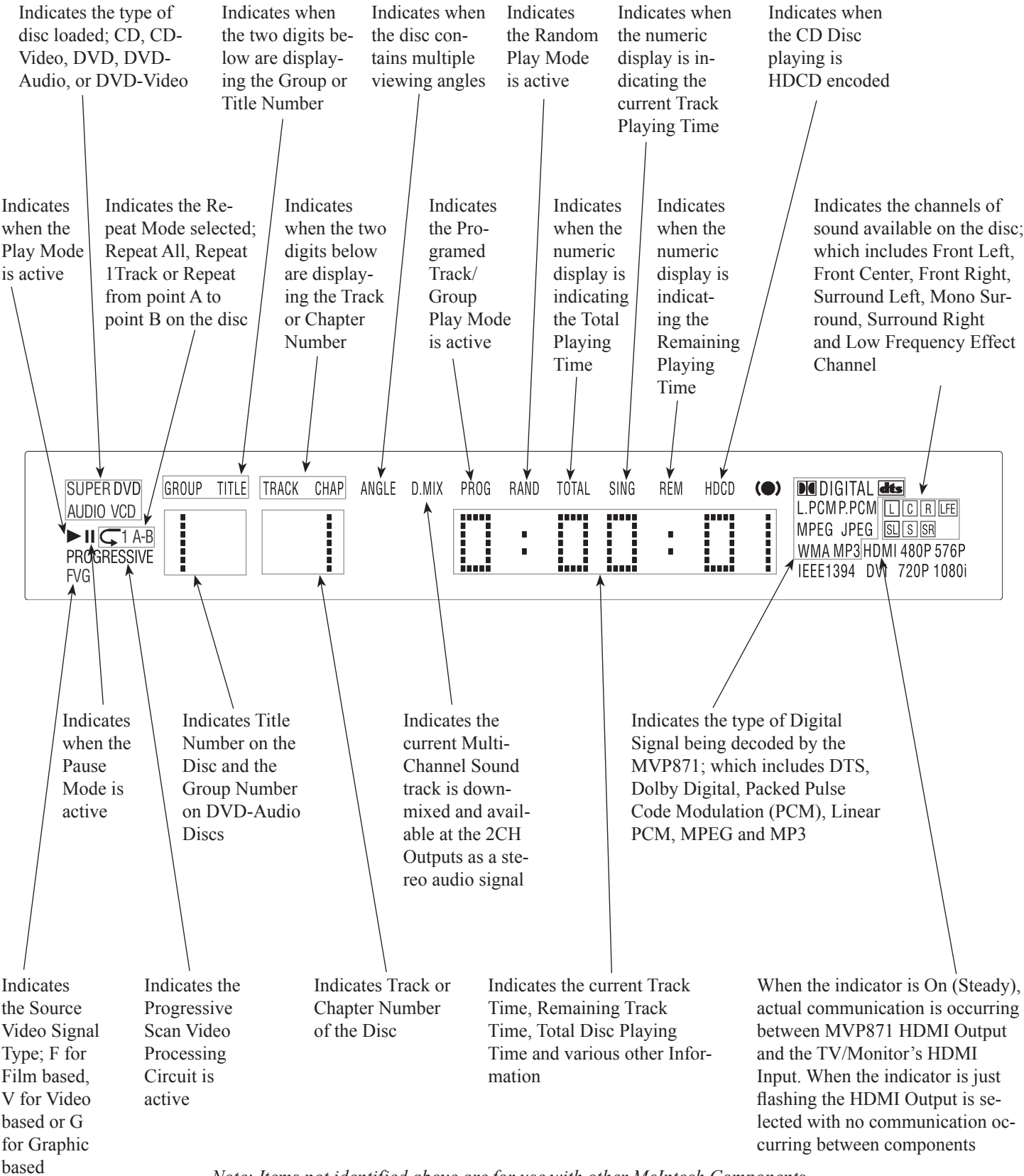

Note: Items not identified above are for use with other McIntosh Components



Use to select NTSC or PAL video output format

Use to change the brightness of the Front Panel Alphanumeric Display from bright to off

Use to toggle the power On and Off to the MVP871

Use to access the standard or one of five preset user defined video settings

Use to access the Setup Menu

Access any numbered operating function

Use to switch power On and Off to the MVP871

Use to Clear the last programmed track

To access Track Numbers on CDs and DVD-Audio Discs greater than 10

Press to select between various on-screen pages of information on DVD-Audio Discs

Use to view on-screen the current title, chapter, group or track number along with direct access to change it using the number push-buttons

Return to the previous setup menu screen

Use to view and/or change the on-screen subtitle language

Use to move the on-screen cursor up, down, left, right; also use to select the highlighted on-screen menu item

Use to view or change the current Audio Selection

Use to select various disc information including time. It is displayed on-screen and on the Front Panel Alphanumeric display

Access the on-screen Top Menu from the disc (disc dependent)

Starts Playback of a disc and allows moving forward or backward one chapter at a time on a DVD-Video; or one track at a time on DVD-Audio, SACD and CD Discs

Access the on-screen Disc Menu from a DVD disc

Press for random playback of tracks from Video and Audio CDs

Use to quick stop, full stop or pause the disc playback. Also use to activate the Still Image Video Mode

Press to enlarge the video image from the disc

Move forward or backward through a disc chapter or track, also use to set the Still Video Image step rate

Use to mark up to five starting points on a disc

Use to preselect (program) from an audio disc the desired tracks for playback

Selects the video signal output at the HDMI Output

Use to review the preselected tracks from the disc on the Front Panel Alphanumeric display, while in the program mode

Select a different picture Angle

Selects the SACD or CD Audio Layer from a hybrid disc

Use to select one of various repeat modes

Use to set a starting and ending time segment on a disc for continuous repeat play

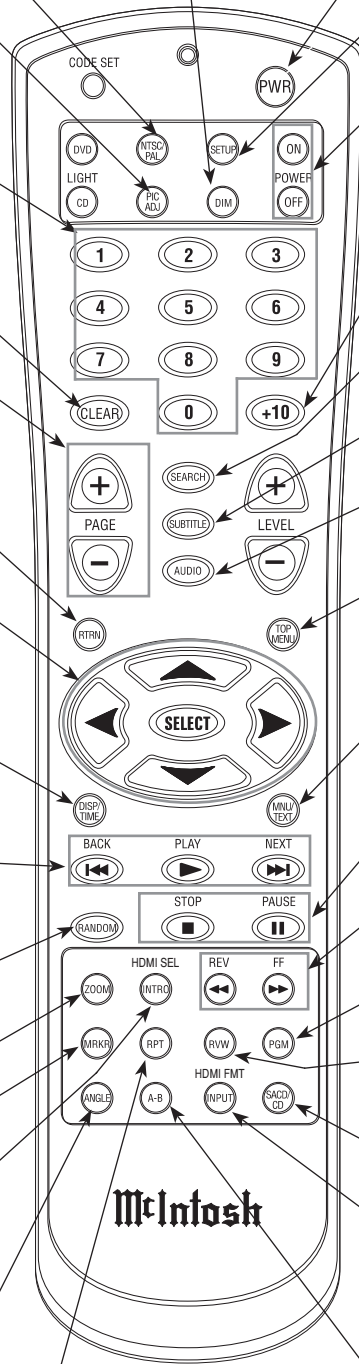

Note: Push-buttons whose function is not identified above are for use with other McIntosh Components

How to use the Remote Control

The Remote Control is capable of performing both basic Operating Functions and Setup Options for the MVP871 Disc Player.

Notes: Refer to the "How to Operate" and "How to Operate Setup Mode" Sections of this manual for additional information using this Remote Control.

Play

With a disc loaded, press the PLAY ► push-button to start the disc playing.

Stop

Press the STOP ■ Push-button once to stop disc playback. Press PLAY and the disc will start playing again from the disc time where Stop was pressed. Press STOP ■ twice for a complete stop and return to the beginning of a disc.

Numbered Push-buttons

Press 1 through 9 to directly access one of the first nine Disc Tracks/Chapters using the On-screen Icon. For track numbers greater than 10, press the +10 Push-button first and then the required number. For example to access Disc Track/Chapter 23, press +10 twice and then 3.

Clear

Press the CLEAR Push-button to erase a selected track or incorrect setting.

Pause

Press the PAUSE || Push-button to temporarily stop disc playback at any time. When a DVD is playing, each additional time the Pause Push-button is pressed, the player will proceed to the next Still Video Image.

Note: The Still Video Image step rate may be changed by using the REV (Reverse) ◀◀ or FF (Fast Forward) ▶▶ Push-button.

Back and Next

Press the NEXT ▶▶ Push-button to move forward or the BACK ◀◀ Push-button to move backward one chapter/track at a time on the disc.

Return

Press the RTRN (Return) Push-button to return to the previous setup menu.

Setup

Press the SETUP Push-button to access the Initial Setup Menu.

Subtitle

Press the SUBTITLE Push-button to access the Subtitle menu and the Subtitle icon will appear at the top of the screen.

Marker

While a disc is playing, use the MRKR (Marker) Push-button to establish in memory up to five different starting points on a disc where you wish play to start.

Angle

If the DVD being played supports the Angle Feature, press the ANGLE Push-button to select the desired video picture angle.

Four Direction Arrows

Press an Arrow direction Push-button to move backward, forward, up or down through an on-screen menu.

Select

Press the SELECT Push-button to confirm and activate a setup option or options indicated by the on-screen icons.

Note: The SELECT push-button is also referred to as "Return" when working within the Setup Mode.

Top Menu

When a disc is loaded in the player, press the TOP MENU Push-button to access the main DVD Title menu (disc dependent).

Display/Time

Press the DISPlay/TIME Push-button to access various disc times, text information on SACD/CD and audio modes displayed on-screen (disc dependent).

Audio

Press the AUDIO Push-button to access various audio modes displayed on-screen (disc dependent).

REV and FF

Press a REV (Reverse) ◀◀ or FF (Fast Forward) ▶▶ Push-button to start moving rapidly through a chapter or track on a disc.

Note: Audio level is automatically muted during this operating mode with a DVD disc.

A-B Repeat

Press the A-B (Repeat) Push-button once to establish the starting point of the repeat loop and press the A-B (Repeat) Push-button a second time for the ending point, and that segment of a disc to be repeated continuously.



How to Operate the Setup Mode

Your McIntosh MVP871 has been factory configured for default operating settings that will allow you to immediately enjoy superb video and high fidelity audio from a DVD-Video. It also reproduces DVD-Audio, SACDs and CDs with unparalleled sonic purity. If you wish to make changes to the factory default settings, a Setup feature is provided to customize the operating settings using the On Screen Display (OSD) Menus.

The On-Screen Menuing System is interactive and the ability to change a given setting or whether some menus appear, is dependent on the operational state of the player and the choices made in other menu items. If a disc is playing in the MVP871 and the STOP Push-button is pressed once (the disc playback is paused), some but not all menu items are available for change. To make all of the menu items available for possible change, the playback of the disc must be stopped which requires two presses of the STOP Push-button.

Notes: The MVP871 must be connected to a MONITOR/TV either through an A/V Control Center or directly, for setup and use. The Remote Control supplied with the McIntosh MVP871 has several Push-buttons that are labeled differently than as indicated on the On Screen Menu, please refer to the following Setup Instructions in this Owner's Manual for the correct Push-button.

1. The Red LED above the STANDBY/ON switch lights to indicate the MVP871 is in Standby mode. To Switch ON the MVP871, press the STANDBY/ON Push-button on the Front Panel or on the Remote Control either the PWR(Power) or POWER ON Push-button.

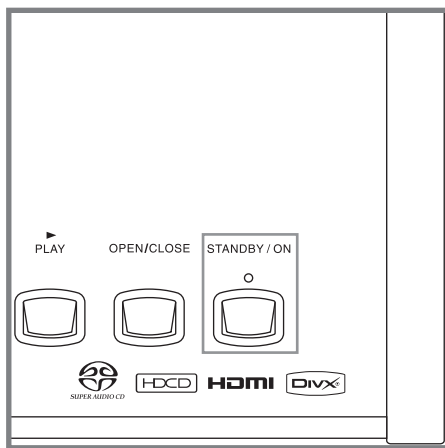

Figure 1

Refer to figures 1 and 2.

Note: When AC Power is initially applied to the MVP871 the unit will momentarily switch On and then go into the Standby Mode.

2. Press the SETUP Push-button on the Remote Control and the LANGUAGE SETUP Menu will appear on the Monitor/TV screen. Refer to figures 2 & 3.

Note: There are six Main Menu Icon Tabs located at the Top of the On-Screen Setup Display. The Icon Tabs are named Language Setup, Digital Interface Setup, Video Setup, Audio Setup, Ratings and Other Setup.

3. Access the desired Main Menu Icon Tab by pressing the Right▶ or Left◀ directional Push-buttons on the supplied Remote Control. Then use the Up▲ or Down▼ directional Push-buttons followed by the SELECT Push-button for the desired choice.

Note: Some menu choices require more than one step to complete.

4. After all the desired setup adjustments are complete, press the SETUP Push-button to exit the Setup Mode.

Note: Some changes made to the menu options will not occur until after the SETUP Mode has been exited.

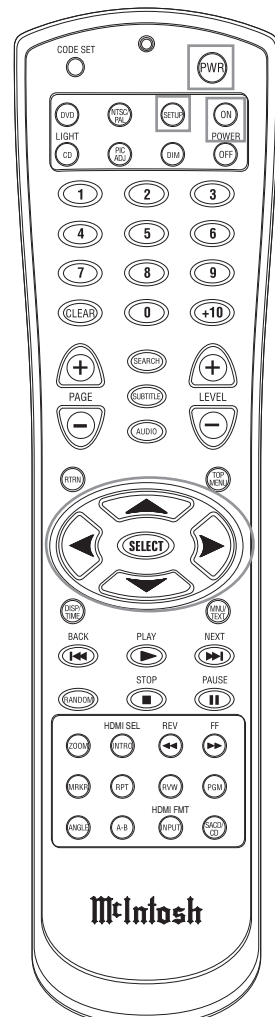

Figure 2

Main Menu Icon Tabs

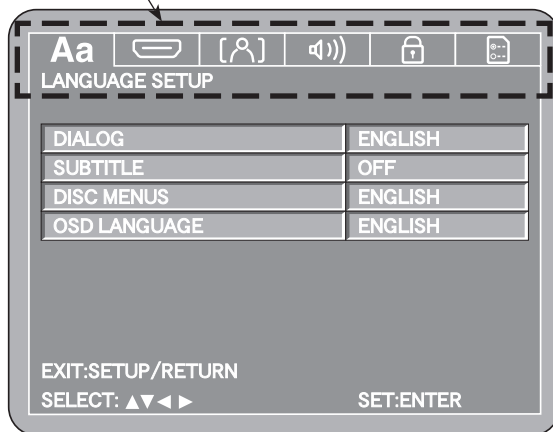

Figure 3

Setup Mode Default Settings

The following listings indicate the factory default settings. Refer to the listed page number for instructions on how to change a default setting.

MAIN SETTINGS FOR:

Language Setup:

Name	Selection	Refer to Page
Dialog.....	English	20
Subtitle.....	Off.....	20
Disc Menu.....	English	20
OSD Language	English	21

Digital Interface Setup:

Name	Selection	Refer to Page
HDMI RGB Setting.....	Normal	21
HDMI Audio Setup	2CH	22

SPEAKER CONFIGURATION SETTINGS:

Speaker Size:

Name	Selection	Refer to Page
Front Sp.....	Large.....	23
Center	Large.....	23
Subwoofer Sp.....	Yes	23
Surround Sp.....	Large.....	23
Crossover	80Hz	23

Speaker Level:

Name	Initial Level	Refer to Page
Front L Ch.....	0dB	23
Center	0dB	23
Front R Ch	0dB	23
Surround R Ch.....	0dB	23
Surround L Ch.....	0dB	23

Speaker Delay Time:

Name	Delay Time	Refer to Page
Front L Ch.....	12ft.....	24
Front R Ch	12ft.....	24
Center	12ft.....	24
Surround L Ch.....	10ft.....	24
Surround R Ch.....	10ft.....	24
Subwoofer	12ft.....	24
Default	On	24

HDMI Auto Format.....	Panel Res.....	25
-----------------------	----------------	----

Video Setup:

Name	Selection	Refer to Page
TV Aspect.....	Wide (16:9).....	26
TV Type	Multi.....	26
Component Video Out.....	Progressive.....	27
Audio/Video Sync	Progressive.....	28
Squeeze Mode.....	Off.....	28
Progressive Mode	Auto.....	29
Pixel Cropping	Off.....	29

Audio Setup:

Name	Selection	Refer to Page
Audio Channel.....	Multi-channel.....	30

AUDIO SPEAKER CONFIGURATION SETTINGS:

Speaker Size:

Name	Selection	Refer to Page
Front.....	Large.....	30
Center	Large.....	30
Subwoofer.....	Yes	30
Surround.....	Large.....	30
Crossover	80Hz	30

Speaker Level:

Name	Initial Level	Refer to Page
Front L Ch.....	0dB	31
Center	0dB	31
Front R Ch	0dB	31
Surround R Ch.....	0dB	31
Surround L Ch.....	0dB	31
Subwoofer.....	0dB	31
SW+10.....	Off	32

Speaker Delay Time:

Name	Delay Time	Refer to Page
Front L Ch.....	12ft.....	32
Front R Ch	12ft.....	32
Center	12ft.....	32
Surround L Ch.....	10ft.....	32
Surround R Ch.....	10ft.....	32
Subwoofer.....	12ft.....	32
Default	On	32

Digital Out.....	Normal	33
Down Sampling	Off.....	33
Source Direct	Off.....	33
Bass Enhancer	Off.....	34
Compression	Off.....	34

Ratings:

Name	Selection	Refer to Page
Rating Level.....	8(No Limit).....	35
Password	Change	35
Registration.....	Show Code.....	36

Other Setup:

Name	Selection	Refer to Page
Player Mode.....	Audio.....	37
Captions	Off.....	37
Wall Paper.....	Blue	37
Screen Saver	Off.....	38
Display	Off.....	38
Auto Power Mode	Off.....	38
Slide Show	5 sec	39



Language Setup

This is to select the Language of the Soundtrack, Subtitles, Disc Menus and On Screen Display (OSD).

Dialog

This selects the dialog language that will be heard when the DVD Disc is played.

Note: The Alternate Languages of French, Spanish and others may not be available on all DVD Discs.

1. Press the SETUP Push-button on the supplied Remote Control to access the Language Setup Menu. Refer to figures 4 and 5.

Note: If there is a Disc playing in the MVP871 press the STOP Push-button twice before pressing the SETUP Push-button.

2. Use the Down▼ directional Push-button on the Remote Control to select the Dialog Menu.

3. To change from the default setting use the Right▶ directional Push-button followed by Up▲ or Down▼ directional Push-buttons and then press the SELECT Push-button.

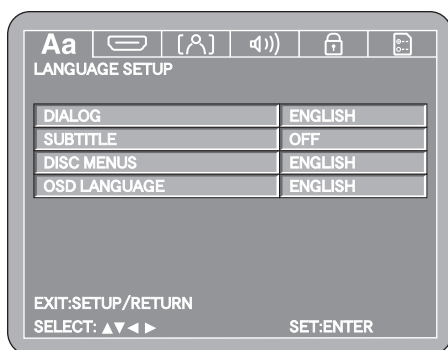

Figure 4

Note: The title of the icon button-bar will change color from yellow (the cursor color) to blue indicating the selected item.

4. Return to the Language Setup Menu by pressing the Left◀ followed by the Up▲ directional Push-buttons.
5. Next continue to the SUBTITLE Settings. If no other changes are to be made in Setup Mode at this time, exit by pressing the RTRN (Return) Push-button.

Note: The SETUP Push-button may also be pressed to exit the setup mode.

Subtitle

This selects the language that will be seen on the TV/Monitor when a DVD Disc is played and the Subtitle Mode is active.

Note: The Alternate Languages of French, Spanish and others may not be available on all DVD Discs.

1. Press the SETUP Push-button on the supplied Remote Control to access the Language Setup Menu. Refer to figures 4 and 5.
2. Use the Down▼ directional Push-button on the Remote Control to select the SUBTITLE Menu. Refer to figure 6.

3. To change from the default setting use the Right▶ directional Push-button followed by Up▲ or Down▼ directional Push-buttons and then press the SELECT Push-button.

Note: The title of the icon button-bar will change color from yellow (the cursor color) to blue indicating the selected item.

4. Return to the Language Setup Menu by pressing the Left◀ followed by the Up▲ directional Push-buttons.

5. Next continue to the DISC MENU Settings. If no other changes are to be made in Setup Mode at this time, exit by pressing the RTRN (Return) Push-button.

Note: The SETUP Push-button may also be pressed to exit the setup mode.

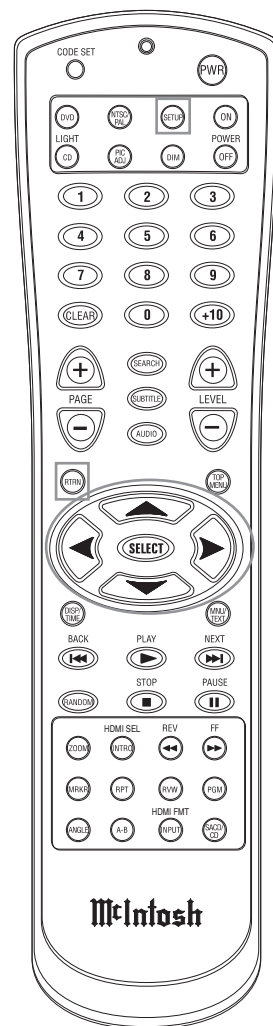

Figure 5

Disc Menus

This selects the language of the menus that will be seen on the TV/Monitor.

Note: The Alternate Languages of French and Spanish may not be available on all DVD Discs.

1. Press the SETUP Push-button on the supplied Remote Control to access the Language Setup Menu. Refer to figures 4 and 5.

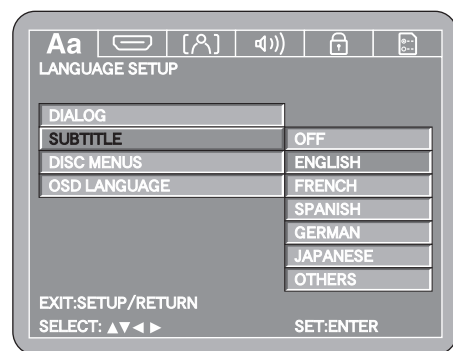

Figure 6

2. Use the Down▼ directional Push-button on the Remote Control to select the DISC MENU item.
3. To change from the default setting use the Right▶ directional Push-button followed by Up▲ or Down▼ directional Push-buttons and then press the SELECT Push-button.

Note: The title of the icon button-bar will change color from yellow (the cursor color) to blue indicating the selected item.

4. Return to the Language Setup Menu by pressing the Left◀ followed by the Up▲ directional Push-buttons.
5. Next continue to the OSD LANGUAGE Settings. If no other changes are to be made in Setup Mode at this time, exit by pressing the RTRN (Return) Push-button.

Note: The SETUP Push-button may be also pressed to exit the setup mode.

OSD Language

This selects the language of the on screen menus that will be seen on the TV/Monitor. To change from English to another language perform the following steps:

Note: The Alternate Languages of French and Spanish may not be available on all DVD Discs when viewing their menus.

1. Press the SETUP Push-button on the supplied Remote Control to access the Language Setup Menu. Then press the Right▶ directional Push-button to select the OSD Setup Menu Icon Tab. Refer to figures 4 and 5.

Note: If there is a Disc playing in the MVP871 press the STOP Push-button twice before pressing the SETUP Push-button.

2. Use the Down▼ directional Push-button on the Remote Control to select the OSD LANGUAGE Menu.
3. To change from the default setting use the Right▶ directional Push-button followed by Up▲ or Down▼ directional Push-buttons and then press the SELECT Push-button.

Note: The title of the icon button-bar will change color from yellow (the cursor color) to blue indicating the selected item.

4. Return to the Language Setup Menu by pressing the Left◀ followed by the Up▲ directional Push-buttons.
5. Next continue to the DIGITAL INTERFACE SETUP Settings. If no other changes are to be made in Setup Mode at this time, exit by pressing the RTRN (Return) Push-button.

Note: The SETUP Push-button may also be pressed to exit the setup mode.

Digital Interface Setup

This selects the various options when the MVP871 is connected to the TV/Monitor either directly or thru a McIntosh A/V Control Center using the connection.

RGB Setting

1. Press the SETUP Push-button on the supplied Remote Control to access the On-Screen Language Setup Menu. Then press the Right▶ directional Push-button to select the Digital Interface Setup Tab. Refer to figures 5 and 7.

Note: If there is a Disc playing in the MVP871 press the STOP Push-button twice before pressing the SETUP Push-button.

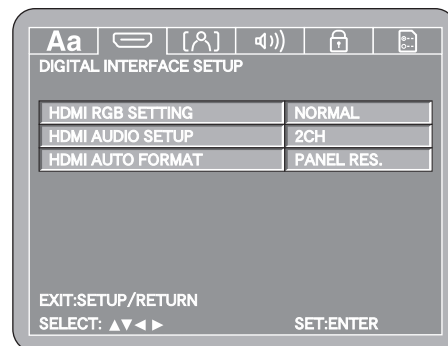

Figure 7

2. Use the Down▼ directional Push-button followed by the Right▶ directional Push-button on the Remote Control.

The RGB setting expands the range of the luminance picture information from black to white. The Enhanced setting may provide a slightly improved image with some TV/Monitors.

Notes: The output signal format needs to be set to the "RGB" Mode. Not all TV/Monitors will support the RGB Mode. To make changes using the Front Panel Selector (SELECT and FORMAT Push-buttons) exit the SETUP Mode.

3. To change from the NORMAL setting use the Up▲ or Down▼ directional Push-buttons followed by the SELECT Push-button. Refer to figure 8.

Note: The title of the icon button-bar will change color from yellow (the cursor color) to blue indicating the selected item.

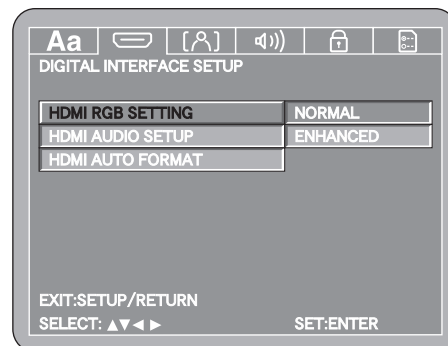

Figure 8

Digital Interface Setup, con't

- Return to the Video Setup Menu by pressing the Left◀ followed by the Up▲ directional Push-buttons.
- Next continue to the AUDIO SETUP Settings. If no other changes are to be made in Setup Mode at this time, exit by pressing the RTRN (Return) Push-button.

Note: The SETUP Push-button may also be pressed to exit the setup mode.

Audio Setup

The Audio Setup selects the number of channels and additional settings of the Digital Audio Signal leaving the MVP871 through the connection.

- Press the SETUP Push-button on the supplied Remote Control to access the On-Screen Language Setup Menu. Then press the Right▶ directional Push-button to select the Digital Interface Setup Tab. Refer to figures 5 (on page 20) and 9.

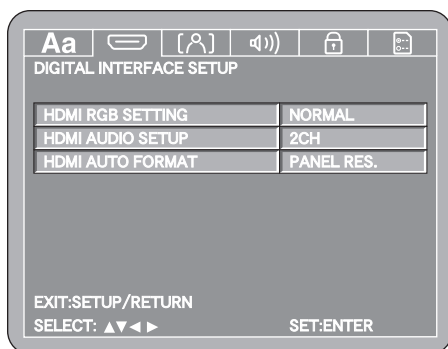

Figure 9

Note: If there is a Disc playing in the MVP871, press the STOP Push-button twice before pressing the SETUP Push-button.

- Use the Down▼ directional Push-button followed by the Right▶ directional Push-button on the Remote Control to select Audio Setup. Refer to figure 10.

The 2CH default setting passes thru a two channel digital audio signal and a two channel digital audio signal down mixed from a multi-channel disc.

Note: If either of the MULTIchannel settings below are chosen, the MVP871 Audio Setup's

Audio Channel Menu item automatically switches to MULTI CHANNEL and will use the same settings as

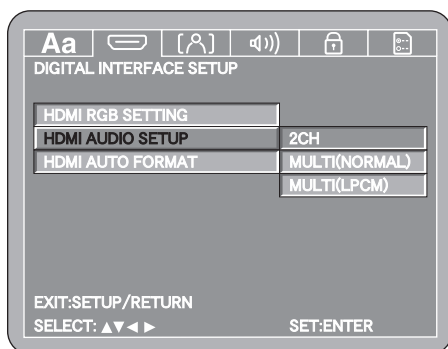

Figure 10

the Audio Setup for Speakers Configuration, Channel Levels and Delay Time; the only exception being there is no SW+10dB adjustment.

The MULTIchannel (NORMAL) setting passes thru the digital audio signal unaltered.

- To change from 2Channel setting to the MULTIchannel (NORMAL) use the Up▲ or Down▼ directional Push-buttons followed by the SELECT Push-button. Refer to figure 10.

The last setting MULTIchannel (LPCM), will decode the Digital Audio Signal from the disc and will re-encode it into a digital PCM Audio Signal. It will also allow adjustments for Speaker Configuration, Channel Level and Delay Time.

The circuitry in the MVP871 queries the Inputs of all the components connected, looking for the number of channels. The number of channels displayed On Screen and their possible adjustments are determined by the results of the query.

- To change from 2Channel setting to the MULTIchannel (LPCM) use the Up▲ or Down▼ directional Push-buttons followed by the SELECT Push-button. Refer to figure 10.
- The HDMI Speaker Setup Menu will now appear On-Screen. Refer to figure 11.

Notes: The title of the icon button-bar will change color from yellow (the cursor color) to blue indicating the selected item. The following steps for Multichannel Loudspeaker Adjustments (Speaker Configuration, Channel Level and Delay Time) are also the same for a 2-Channel Loudspeaker System. If the query detected a 2-Channel Audio component connected, only the Front Left and Right Menu items will be adjustable.

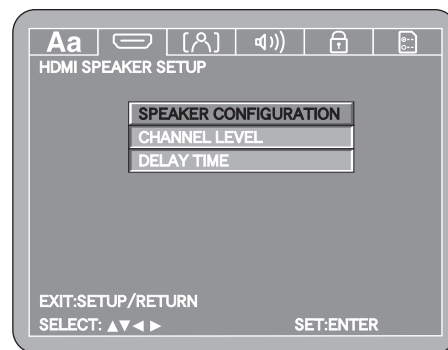

Figure 11

LOUDSPEAKER SIZE CONFIGURATION:

In the steps below the size of the Loudspeakers will be entered into setup. The LARGE Setting refers to the Loudspeaker capability for reproducing bass frequencies down to 35Hz within -3dB of the midrange frequencies. If a Loudspeaker can not reproduce bass frequencies down to

35Hz within -3dB of the midrange frequencies it is considered SMALL.

1. Use the Up▲ or Down▼ directional Push-button to select SPEAKER CONFIGURATION followed by pressing the SELECT Push-button on the Remote Control. Refer to figures 11 and 12.

2. Press the Down▼ directional Push-button and then press the Right▶ directional Push-button followed by the Up▲ or Down▼ directional Push-button

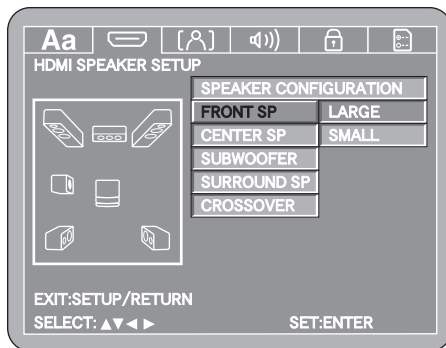

Figure 12

to select Large or Small Loudspeaker Size for the Front Loudspeakers connected in the system. Using the directional push-buttons and the On-Screen Menu proceed to the remaining Loudspeakers in the system and select Large, Small or None.

Note: If the Front Loudspeakers are set to small, the Center and Surround Loudspeaker will automatically switch to small with the Large Menu Setting grayed out. The Subwoofer setting is fixed to the On setting as this is required to playback DVD-Audio Discs properly.

3. Use the Down▼ directional Push-button to select CROSSOVER press the Right▶ directional Push-button followed by using the the Up▲ or Down▼ directional Push-buttons followed by pressing the SELECT Push-button to select the crossover frequency between the subwoofer and the Front/Surround Loudspeakers. Refer to the Owner's Manuals that came with your Loudspeakers and/or contact your McIntosh Dealer for assistance in determining the appropriate Crossover Frequency.
4. Press the RTRN (Return) Push-button to return to the SPEAKER CONFIGURATION Menu.

CHANNEL LEVEL ADJUSTMENTS:

A properly setup Home Theater Surround Sound System should have all Loudspeaker levels adjusted to the same starting reference volume level in the Listening/Viewing Area. The MVP871 includes a built-in test signal generator, which can have its output switched into each Loudspeaker manually or automatically. The desired test signal volume levels of each Loudspeaker can be determined, in

the Listening/Viewing Area, either by listening or with a sound pressure meter. Level adjustments are made in small steps (1dB) by using the MVP871 Remote Control Up▲ or Down▼ directional Push-buttons. The level can be adjusted over a 10dB range.

Note: Before performing the Loudspeaker Level adjustments, you must first have completed the Loudspeaker Size adjustments.

1. Use the Down▼ directional Push-button to select CHANNEL LEVEL followed by pressing the SELECT Push-button on the Remote Control. Refer to figures 13 and 14.

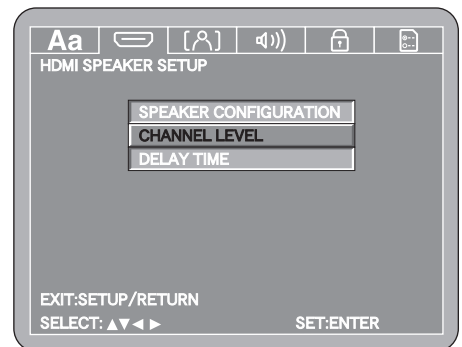

Figure 13

2. Use the Down▼ directional Push-button to select TEST TONE then press the Right▶ or Left◀ directional Push-buttons to select the MANUAL Selection Mode of operation. Refer to figure 15.

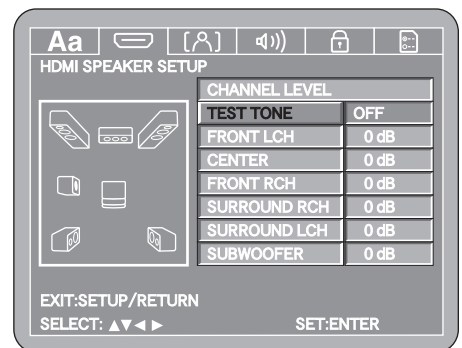

Figure 14

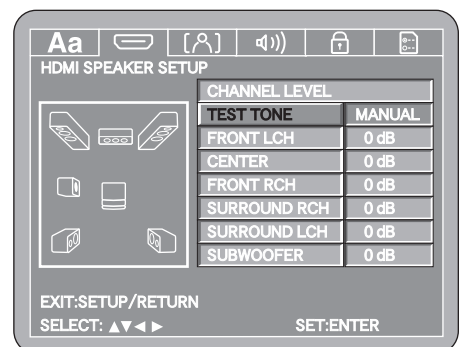

Figure 15

Note: The procedure used for making the Loudspeaker Level Adjustments is similar for both the Manual and Automatic Modes. The only difference is, in the Manual Mode the selection of the Loudspeaker is performed by using the Up▲ or Down▼ directional Push-buttons before adjustments are made. In the Automatic Mode, the MVP871 will switch

Digital Interface Setup, con't

to the next Loudspeaker three seconds after user adjustments have stopped. Refer to figure 16 if the Automatic Mode will be used.

- Use the Down▼ directional Push-button to select the different Loudspeakers and the Right► or Left◀ directional Push-buttons to adjust the Loudspeaker Volume Level to match the volume level of the other Loudspeakers. This may take several cycles through all the Loudspeakers to achieve the desired results. If one of the Loudspeakers is quieter than the others, use it as a reference to match the other loudspeakers to.
- When all the Loudspeakers are at the same volume level press the RTRN (Return) Push-button to stop the Channel Level Adjustments and then press the RTRN Push-button again to return to the SPEAKER CONFIGURATION Menu.

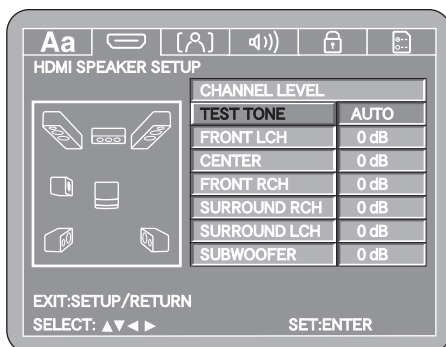

Figure 16

DELAY TIME ADJUSTMENTS:

The following Delay Time Adjustments will electronically compensate for different Loudspeaker distances from the Listening/Viewing Area. Refer to figure 17. Delay Time is measured in feet or meters. The delays can be adjusted from 0 foot to 27 feet in one foot increments for each Loudspeaker.

Note: Before performing the Delay Time adjustments, you must first have completed the Loudspeaker Size and Level adjustments.

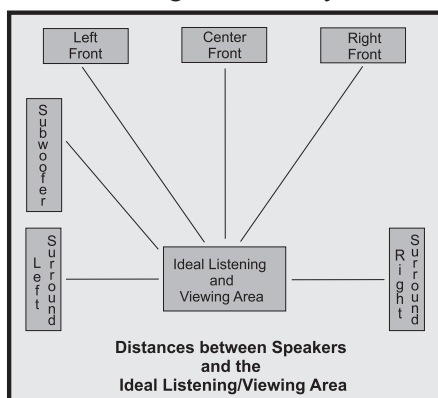

Figure 17

- Measure the distances of the Loudspeakers used in the Home Theater System, from the Listening/Viewing Area to each Loudspeaker to within the nearest foot or tenth of a meter.
- Use the Down▼ directional Push-button to select

DELAY TIME followed by pressing the SELECT Push-button on the Remote Control. Refer to figure 18.

- Use the Down▼ directional Push-button to select DISTANCE then press the Right► or Left◀ directional Push-buttons to select the desired measurement increments, either Feet or Meters. Refer to figure 19

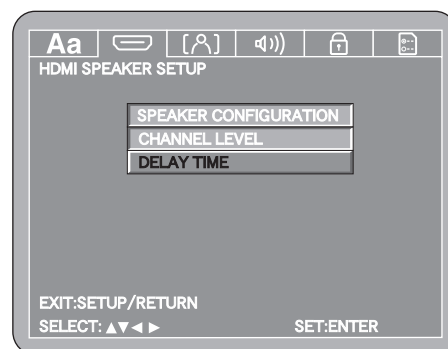

Figure 18

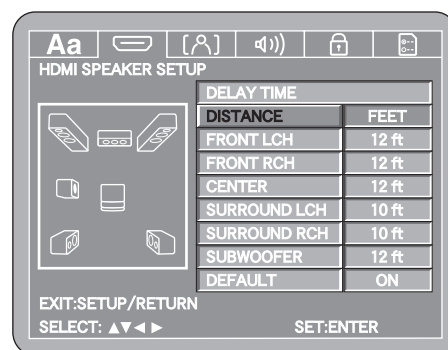

Figure 19

- Use the Down▼ directional Push-button to select FRONT LCH then use the Right► or Left◀ directional Push-buttons to enter in the distance of the Loudspeaker from the Listening/Viewing Area. Refer to figure 20.

Note: To reset all the Loudspeaker Delay Time settings to the default settings first select

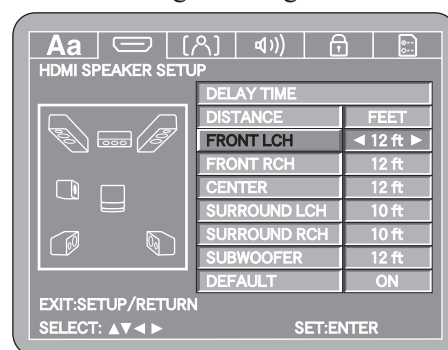

Figure 20

DEFAULT menu choice and then press the SELECT Push-button.

- Enter in the distances for the remaining Loudspeakers.
- When all the Loudspeaker distances are entered, press the RTRN (Return) Push-button twice to return to the Digital Interface Setup.
- Next continue to the HDMI AUTO FORMAT Settings. If no other changes are to be made in Setup Mode at this time, exit by pressing the RTRN (Return) Push-button.

Note: The SETUP Push-button may also be pressed to exit the setup mode.

Auto Format

TV/Monitors with Fixed Pixel Display, such as DLP, LCD, LiCos and Plasma all have native resolution that all incoming video signals are converted to. The MVP871 allows for both manual and automatic selection of video resolution.

The default setting PANEL RES. will output the Digital Video signal at the native resolution of the TV/Monitor.

The MAX RES. will set the video output resolution to the maximum resolution the TV/Monitor process.

When the Front Panel Format is set to “Y, C_R, C_B AUTO” the circuitry inside the MVP871 will automatically select the appropriate resolution.

1. Press the SETUP Push-button on the supplied Remote Control to access the On-Screen Language Setup Menu. Then press the Right▶ directional Push-button to select the Digital Interface Setup Tab. Refer to figures 5 (on page 20) and 21.

Note: If there is a Disc playing in the MVP871, press the STOP Push-button twice before pressing the SETUP Push-button.

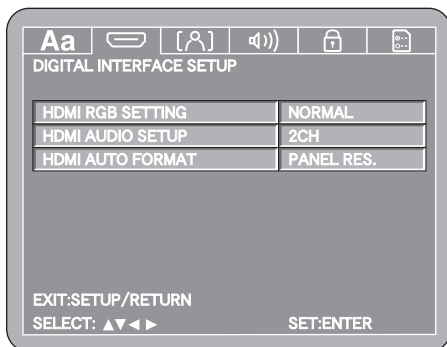

Figure 21

2. Use the Down▼ directional Push-button on the Remote Control to select HDMI Auto Format. Refer to figure 22.

3. Use the Right▶ directional Push-button followed by the Up▲ or Down▼ directional Push-buttons to select MAX RES. Then press the SELECT Push-button.

4. Next continue to the Video Setup Menu item starting on page 26. If no other changes are to be made in Setup Mode at this time, exit by pressing the RTRN (Return) Push-button.

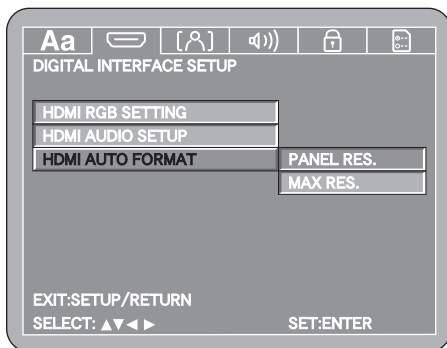
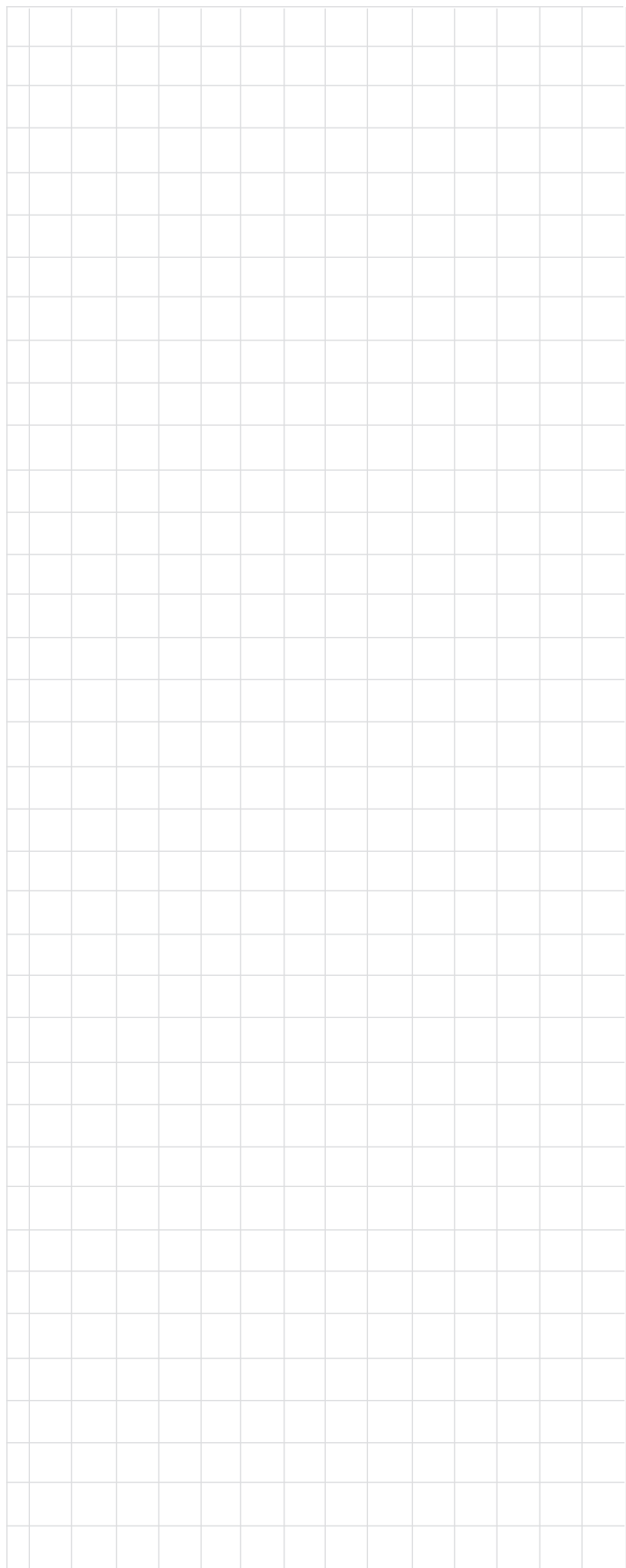

Figure 22

Note: The SETUP Push-button may also be pressed to exit the setup mode.





Video Setup

TV Aspect

This selects the proper display ratio of height and width to match the TV/Monitor connected to the MVP871. To change from the default setting of Wide (16:9) perform the following steps:

1. Press the SETUP Push-button on the Remote Control to access the Language On-Screen Setup Menu. Then press the Right▶ directional Push-button to select the Video Setup Menu Icon Tab. Refer to figure 23.

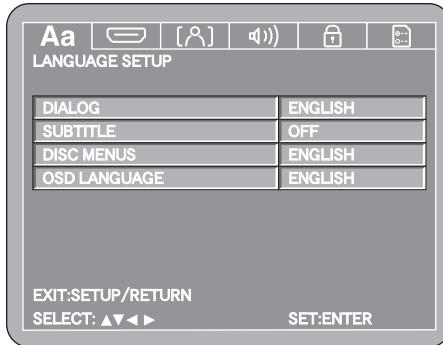

Figure 23

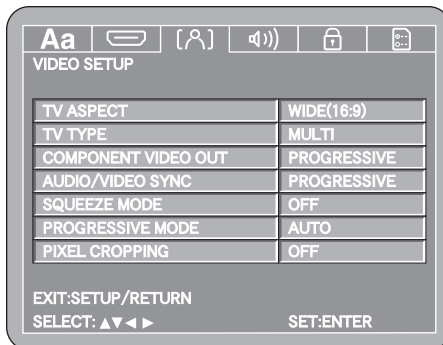

Figure 24

Note: If there is a Disc playing in the MVP871 press the STOP Push-button twice before pressing the SETUP Push-button.

2. Use the Down▼ directional Push-button followed by the SELECT Push-button on the Remote Control to select the TV ASPECT Menu. Refer to figures 24 and 25.

3. To change from the Wide (16:9) setting use the Up▲ or Down▼ directional Push-buttons followed by the SELECT Push-button:

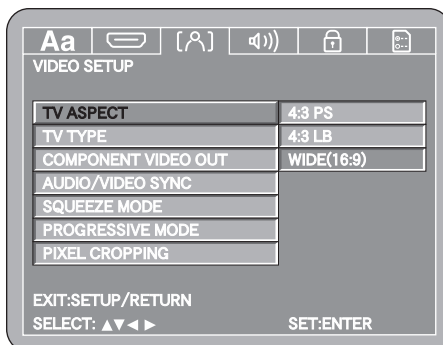

Figure 25

- (4:3 PS) Conventional Screen Mode with Pan and Scan Format refer to figure 25.

- (4:3 LB) Conventional Screen Mode with Letter Box Format refer to figure 26.

- (16:9) Wide Screen Mode Format refer to figure 27.

Note: The title of the icon button-bar will change color from yellow (the cursor color) to blue indicating the selected item.



Figure 26



Figure 27



Figure 28

4. Return to the Video Setup Menu by pressing the Up▲ directional Push-button.

5. Next continue to the TV TYPE Settings. If no other changes are to be made in Setup Mode at this time, exit by pressing the RTRN (Return) Push-button.

Note: The SETUP Push-button may also be pressed to exit the setup mode.

TV Type

This selects the proper video signal format to match the capabilities of the connected TV/Monitor. To change from the default setting of MULTI perform the following steps:

Notes: The TV Type for use in U.S. and Canada is NTSC, for use in parts of Europe is PAL and the MULTI Mode will automatic select the proper video signal format. If the TV/Monitor is displaying an image without color and/or a loss of Horizontal/Vertical Synchronization, refer to the TV/Monitor Owner's Manual to determine the correct setting to be used.

1. Press the SETUP Push-button on the supplied Remote Control to access the Language Setup Menu. Then

press the Right▶ directional Push-button to select the Video Menu Icon Tab. Refer to figure 24.

Note: If there is a Disc playing in the MVP871 press the STOP Push-button twice before pressing the SETUP Push-button.

2. Use the Down▼ directional Push-button on the Remote Control to select the TV TYPE Menu. Refer to figure 29.

3. To change from the default setting use the Right▶ directional Push-button followed by Up▲ or Down▼ directional Push-buttons and then press the SELECT Push-button.

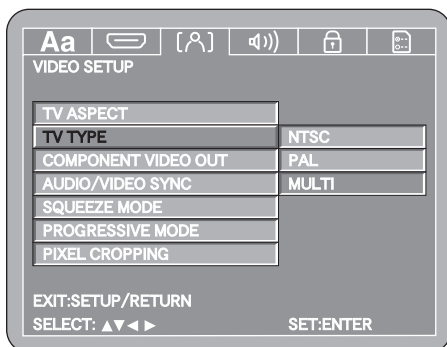

Figure 29

Note: The title of the icon button-bar will change color from yellow (the cursor color) to blue indicating the selected item.

4. Return to the Video Setup Menu by pressing the Left◀ followed by the Up▲ directional Push-buttons.

5. Next continue to the COMPONENT VIDEO OUT Settings. If no other changes are to be made in Setup Mode at this time, exit by pressing the RTRN (Return) Push-button.

Note: The SETUP Push-button may also be pressed to exit the setup mode.

Component Video Out

This selects the video signal format available at the Component Video Jacks to match the capabilities of the connected TV/Monitor. To change from the default setting of Progressive perform the following steps:

Note: The Progressive Scan Circuitry in the MVP871 offers the highest possible analog video picture quality available when the Component Video Outputs of the MVP871 are connected to a TV/Monitor capable of Progressive Scan. Unlike a conventional TV with Odd and Even Scanning Lines that are interlaced together to form a picture, the Progressive Scanning Mode scans all the lines of picture information both Odd and Even at one time, non-interlaced.

1. Press the SETUP Push-button on the Remote Control to access the Language Setup Menu. Then press the Right▶ directional Push-button to select the Video Setup Menu Icon Tab. Refer to figure 24.

Note: If there is a Disc playing in the MVP871 press the STOP Push-button twice before pressing the SETUP Push-button.

2. Use the Down▼ directional Push-button on the Remote Control to select the COMPONENT VIDEO OUT Menu.

Refer to figure 30.

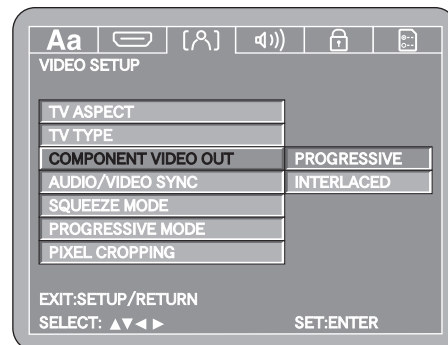

Figure 30

CAUTION: *DO NOT use the MVP871 DVD Player's Progressive Video Display Mode unless you are certain the TV/Monitor connected to the MVP871's Component Video Output jacks is capable of displaying a Progressive Scan Signal. Failure to do so could result in possible damage to the TV/Monitor. If you are not sure about the capability of the TV/Monitor connected to the MVP871 Component Video Output, refer to the Owner's Manual supplied with the set and/or contact your McIntosh Dealer for assistance. In order to switch the MVP871 Component Video Output to the Interlace Mode (non Progressive Scan), the MVP871 will first have to be connected to a TV/Monitor having either Progressive Scan capability or can except either S-Video or Composite Video Signals.*

3. To change from the default setting use the Right▶ directional Push-button followed by Up▲ or Down▼ directional Push-buttons and then press the SELECT Push-button.

Note: The title of the icon button-bar will change color from yellow (the cursor color) to blue indicating the selected item. Not all High definition TV/Monitor sets are fully compatible with the MVP871 and may cause artifacts to be displayed in the picture. In the case of Progressive Scan picture problems, it is recommended to switch off the Progressive Scan feature in the MVP871 and instead use the built-in Progressive Scan feature of the TV/monitor. For additional information please contact your McIntosh Dealer.

Video Setup, con't

- Return to the Video Setup Menu by pressing the Left◀ followed by the Up▲ directional Push-buttons.
- Next continue to the AUDIO/VIDEO SYNC Settings. If no other changes are to be made in Setup Mode at this time, exit by pressing the RTRN (Return) Push-button.

Note: The SETUP Push-button may also be pressed to exit the setup mode.

Audio/Video Sync

Due to the difference in the amount of time it takes for the processing of the Video and Audio signals, they can be out of synchronization which is especially noticeable with dialog. The MVP871 allows for the correction of any loss of sync. There are separate settings for HDMI (Digital Video), Analog Video (both Interlaced and Progressive Scan modes) and OTHER which is a variable setting with an offset delay 0-200ms. The variable delay is useful when multiple video connections such as Interlaced, Progressive and Digital are all used simultaneously. The default setting is Analog Progressive Scan Video. To change from the default setting perform the following steps:

- Press the SETUP Push-button on the supplied Remote Control to access the Language Setup Menu. Then press the Right▶ directional Push-button to select the Video Menu Icon Tab. Refer to figure 24.

Note: If there is a Disc playing in the MVP871 press the STOP Push-button twice before pressing the SETUP Push-button.

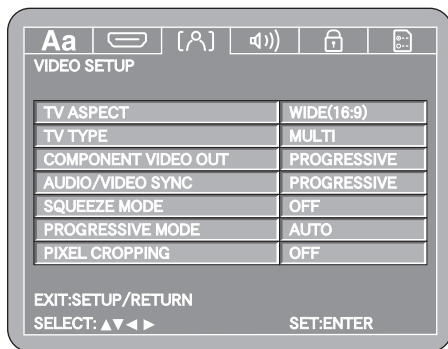

Figure 24

- Use the Down▼ directional Push-button on the Remote Control to select the AUDIO/VIDEO SYNC Menu. Refer to figure 31.
- To change from the default setting use the Right▶ directional Push-button followed by

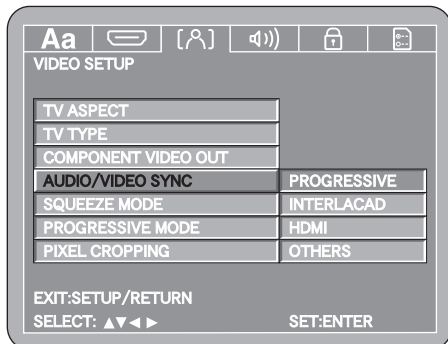

Figure 31

Up▲ or Down▼ directional Push-buttons to select one of two other presets (Interlaced or HDMI) followed by pressing the SELECT Push-button. If a different delay value is needed, use the Up▲ or Down▼ directional Push-buttons to select OTHER followed by the SELECT Push-button. Use the Up▲ or Down▼ directional Push-buttons to enter the offset delay value followed by the SELECT Push-button. Refer to figure 32.

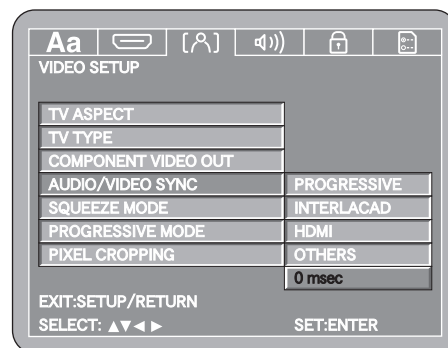

Figure 32

Note: The title of the icon button-bar will change color from yellow (the cursor color) to blue indicating the selected item.

- Return to the Video Setup Menu by pressing the Left◀ followed by the Up▲ directional Push-buttons.
- Next continue to the SQUEEZE MODE Settings. If no other changes are to be made in Setup Mode at this time, exit by pressing the RTRN (Return) Push-button.

Note: The SETUP Push-button may also be pressed to exit the setup mode.

Squeeze Mode

When the MVP871 is connected to a TV/Monitor with either a Component Video or HDMI connection and the TV Aspect Ratio is set to 16:9 and a video source with an Aspect Ratio of 4:3 is displayed, the image will be stretched out. The Squeeze Mode will compensate by displaying the 4:3 image in the center of the screen. The default setting is Off with additional choices of On or Auto. To change from the default setting perform the following steps:

- Press the SETUP Push-button on the supplied Remote Control to access the Language Setup Menu. Then press the Right▶ directional Push-button to select the Video Menu Icon Tab. Refer to figure 24.
Note: If there is a Disc playing in the MVP871 press the STOP Push-button twice before pressing the SETUP Push-button.
- Use the Down▼ directional Push-button on the Remote Control to select the SQUEEZE MODE Menu. Refer to figure 33
- To change from the default setting use the Right▶ directional Push-button followed by Up▲ or Down▼ directional Push-buttons and then press the SELECT Push-button.

Note: The title of the icon button-bar will change color from yellow (the cursor color) to blue indicating the selected item.

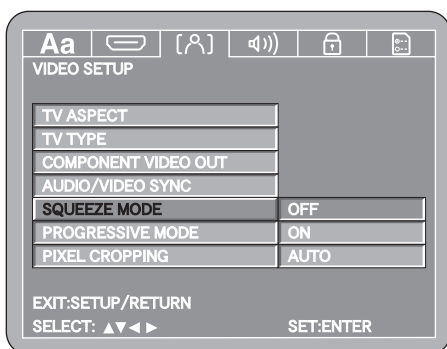

Figure 33

4. Return to the Video Setup Menu by pressing the Left◀ followed by the Up▲ directional Push-buttons.
5. Next continue to the PROGRESSIVE MODE Settings. If no other changes are to be made in Setup Mode at this time, exit by pressing the RTRN (Return) Push-button.

Note: The SETUP Push-button may also be pressed to exit the setup mode.

Progressive Mode

When the Component Video Output (Analog Video) is connected to the TV/Monitor and the Progressive Mode is set to Auto (default setting) the MVP871 will produce the best possible picture quality. The two additional Modes of Progressive Scan “Video1” and “Video2” allow for manual override when the Progressive Scan Circuits can not determine whether the video signal is film or video based. Video1 setting will look best with Video Source material and Video2 will look best with Film Source material. For additional important information on using the Component Video Outputs and the Progressive Scan Mode refer to “Component Video” on page 27. To switch Off the Progressive Scan Mode perform the following:

1. Press the SETUP Push-button on the supplied Remote Control to access the Language Setup Menu. Then press the Right▶ directional Push-button to select the Video Menu Icon Tab. Refer to figure 24.

Note: If there is a Disc playing in the MVP871 press the STOP Push-button

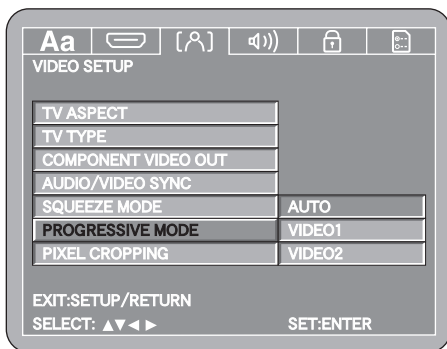

Figure 34

- twice before pressing the SETUP Push-button.
2. Use the Down▼ directional Push-button on the Remote Control to select the PROGRESSIVE MODE Menu. Refer to figure 34.
3. To change from the default setting use the Right▶ directional Push-button followed by Up▲ or Down▼ directional Push-buttons and then press the SELECT Push-button.

Note: The title of the icon button-bar will change color from yellow (the cursor color) to blue indicating the selected item.

4. Return to the Video Setup Menu by pressing the Left◀ followed by the Up▲ directional Push-buttons.
5. Next continue to the PIXEL CROPPING Settings. If no other changes are to be made in Setup Mode at this time, exit by pressing the RTRN (Return) Push-button.

Note: The SETUP Push-button may also be pressed to exit the setup mode.

Pixel Cropping

A small number of TV/Monitors might exhibit some horizontal instability (jitter). This can be removed by Pixel Cropping Circuitry in the MVP871. To activate perform the following:

1. Press the SETUP Push-button on the supplied Remote Control to access the Language Setup Menu. Then press the Right▶ directional Push-button to select the Video Menu Icon Tab. Refer to figure 24.

Note: If there is a Disc playing in the MVP871 press the STOP Push-button twice before pressing the SETUP Push-button.

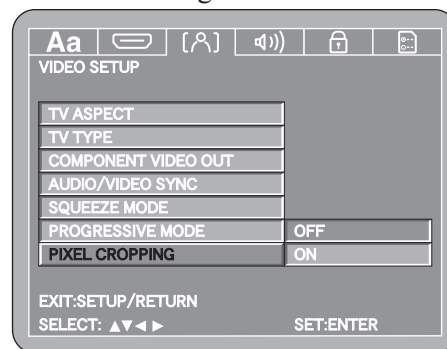

Figure 35

2. Use the Down▼ directional Push-button on the Remote Control to select the PIXEL CROPPING Menu. Refer to figure 35.
3. To change from the default setting use the Right▶ directional Push-button followed by Up▲ or Down▼ directional Push-buttons and then press the SELECT Push-button.

Note: The title of the icon button-bar will change color from yellow (the cursor color) to blue indicating the selected item.

4. Return to the Video Setup Menu by pressing the Left◀ followed by the Up▲ directional Push-buttons.
5. Next continue to the AUDIO SETUP Settings. If no other changes are to be made in Setup Mode at this time, exit by pressing the RTRN (Return) Push-button.

Note: The SETUP Push-button may also be pressed to exit the setup mode.

Audio Setup

The MVP871 has built in Digital Audio to Analog Audio Decoding Circuitry for the various Digital Audio Formats used on today's CD and DVD Discs. These included SACD, DVD-Audio, Dolby Digital, DTS Digital, MP3, WMA, HDCD and DivX. The Audio Channel Setup selects the number of Channels, Loudspeaker Configuration and Delay Time Settings of the Analog Audio Signal leaving the MVP871.

Audio Channel

1. Press the SETUP Push-button on the supplied Remote Control to access the On-Screen Language Setup Menu.

Then press the Right▶ directional Push-button to select the Audio Setup Tab. Refer to figures 5 (on page 20), 36 and 37.

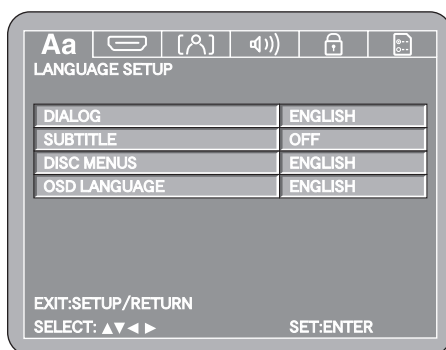

Figure 36

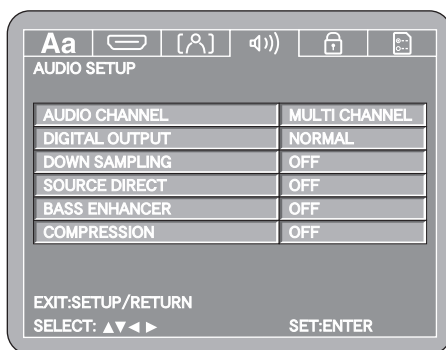

Figure 37

Notes: If there is a Disc playing in the MVP871, press the STOP Push-button twice before pressing the SETUP Push-button. When the HDMI "MULTI (LPCM)" Mode has been selected, this AUDIO CHANNEL Setup is not active.

2. Use the Down▼ directional Push-button followed by the Right▶ directional Push-button on the Remote

Control to select Audio Setup. Refer to figure 38.

MULTI CHANNEL is the default menu selection and has adjustments for Speaker Configuration, Channel Level and Delay Time used after decoding Multichannel Digital Audio Signals into 5.1 Analog Audio Channels.

The 2CH VSS OFF setting passes thru a two channel digital audio signal or two channel digital audio signal down mixed from a multichannel disc with no additional audio signal processing.

The 2CH VSS1 ON and the 2CH VSS2 ON settings pass thru a two channel digital audio signal or two channel digital audio signal down mixed from a multichannel disc with the addition Synthesized Surround Sound Signal Processing.

To perform the MultiChannel adjustments press the Right▶ directional Push-button followed by the SELECT Push-button, then proceed to step 4.

To change from the default setting of MultiChannel to one of the 2CH modes perform step 3.

3. Use the Up▲ or Down▼ directional Push-buttons to select the desired 2CH followed by the SELECT Push-button, then proceed to step 7 on page 33.
4. The Speaker Setup Menu will now appear On-Screen. Refer to figure 39.

Notes: If the "Source Direct" Audio Setup Menu

Option is set to 50kHz or 100kHz the Speaker Configuration is not active. The title of the icon button-bar will change color from yellow (the cursor color) to blue indicating the selected item.

LOUDSPEAKER SIZE CONFIGURATION:

In the steps below the size of the Loudspeakers will be entered into setup. The LARGE Setting refers to the

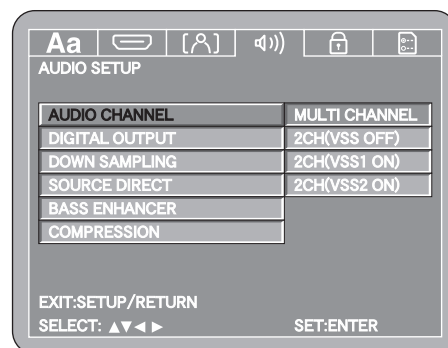

Figure 38

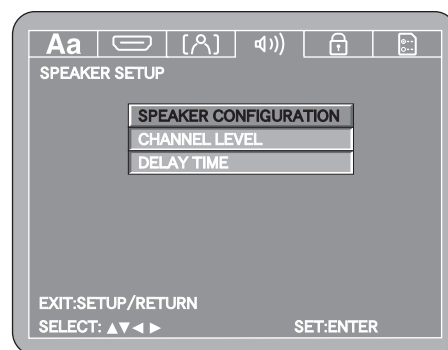

Figure 39

Loudspeaker capability for reproducing bass frequencies down to 35Hz within -3dB of the midrange frequencies. If a Loudspeaker can not reproduce bass frequencies down to 35Hz within -3dB of the midrange frequencies, it is considered SMALL.

1. Use the Up▲ or Down▼ directional Push-button to select SPEAKER CONFIGURATION followed by pressing the SELECT Push-button on the Remote Control. Refer to figure 39.
2. Press the the Down▼ directional Push-button and then press the Right► directional Push-button followed by the Up▲ or Down▼ directional Push-button to select Large or Small Loudspeaker Size for the Front Loudspeakers connected in the system. Using the directional push-buttons and the On-Screen Menu proceed to the remaining Loudspeakers in the system and select Large, Small or None. Refer to figure 40.

Note: If the Front Loudspeakers are set to small the Center and Surround Loudspeaker

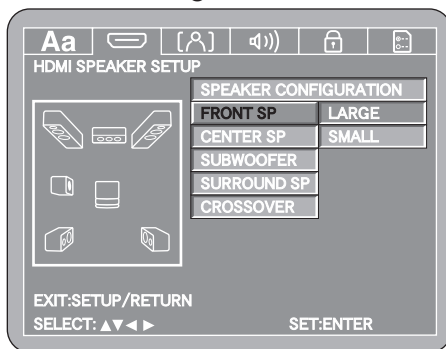

Figure 40

will automatically switch to small and the Subwoofer setting is fixed to the On setting as this is required to playback DVD-Audio Discs properly.

3. Use the Down▼ directional Push-button to select CROSSOVER then press the Right► directional Push-button. Using the Up▲ or Down▼ directional Push-buttons followed by pressing SELECT to make a change from the default setting of 80Hz. This sets the crossover frequency between the subwoofer and the Front/Surround Loudspeakers. Refer to the Owner's Manuals that came with your Loudspeakers and/or contact your McIntosh Dealer for assistance in determining the appropriate Crossover Frequency.
4. Press the RTRN (Return) Push-button to return to the SPEAKER CONFIGURATION Menu.

CHANNEL LEVEL ADJUSTMENTS:

A properly setup Home Theater Surround Sound System should have all Loudspeaker levels adjusted to the same starting reference volume level in the Listening/Viewing Area. The MVP871 includes a built-in test signal genera-

tor, which can have its output switched into each Loudspeaker manually or automatically. The desired test signal volume levels of each Loudspeaker can be determined, in the Listening/Viewing Area, either by listening or with a sound pressure meter. Level adjustments are made in small steps (1dB) by using the MVP871 Remote Control Up▲ or Down▼ directional Push-buttons. The level can be adjusted over a 10dB range.

Note: Before performing the Loudspeaker Level adjustments, you must first have completed the Loudspeaker Size adjustments.

1. Use the Down▼ directional Push-button to select CHANNEL LEVEL followed by pressing the SELECT Push-button on the Remote Control. Refer to figures 41 and 42.

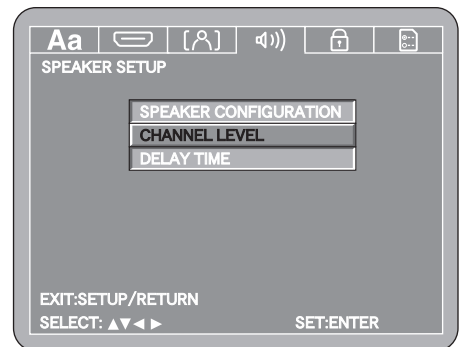

Figure 41

2. Use the Down▼ directional Push-button to select TEST TONE then press the Right► or Left◀ directional Push-buttons to select the MANUAL Selection Mode of operation. Refer to figure 43.

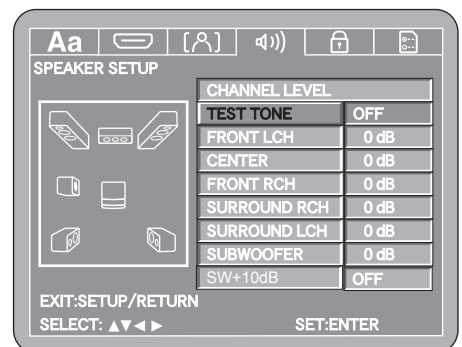

Figure 42

Note: The procedure used for making the Loudspeaker

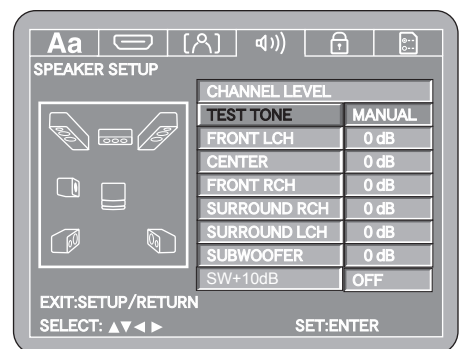

Figure 43

Level Adjustments is similar for both the Manual and Automatic Modes. The only difference is, in the Manual Mode, the selection of the Loudspeaker is performed by using the Up▲ or Down▼ directional Push-buttons before adjustments are made.

How to Set the Audio, con't

In the Automatic Mode, the MVP871 will switch to the next Loudspeaker three

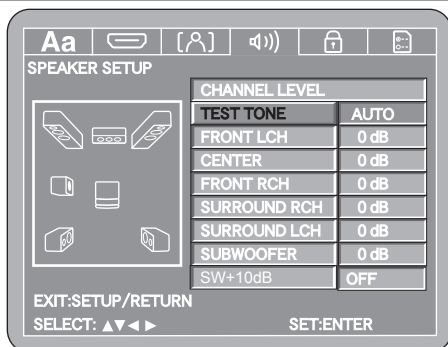

Figure 44

seconds after user adjustments have stopped. Refer to figure 44 if the Automatic Mode will be used.

- Use the Down▼ directional Push-button to select the different Loudspeakers and the Right► or Left◀ directional Push-buttons to adjust the Loudspeaker Volume Level to match the volume level of the other Loudspeakers. This may take several cycles through all the Loudspeakers to achieve the desired results. If one of the Loudspeakers is quieter than the others, use it as a reference to match the other loudspeakers to. If the volume level of the subwoofer can't be adjusted to match the other Loudspeakers with the setup level adjustment set to maximum, return it to 0dB and then switch the SW+10 setting to On and then readjust the Subwoofer level to match the other Loudspeakers.

WARNING: Distortion from the subwoofer is possible if the SW+10dB boost is activated.

- When all the Loudspeakers are at the same volume level, press the RTRN (Return) Push-button to stop the Channel Level Adjustments and then press the RTRN Push-button again to return to the SPEAKER CONFIGURATION Menu.

DELAY TIME ADJUSTMENTS:

The following Delay Time Adjustments will electronically compensate for different Loudspeaker distances from the Listening/Viewing Area. Refer to figure 45. Delay Time is measured in feet or meters. The delays can be adjusted from 0 foot to 27 feet in one foot increments for each Loudspeaker.

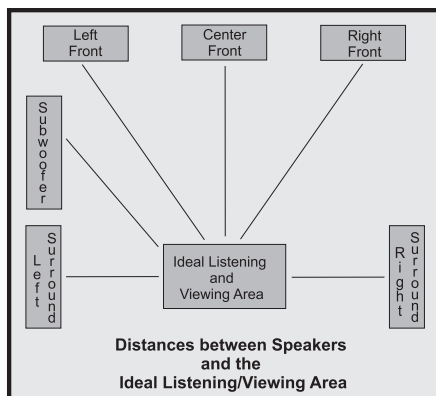

Figure 45

Note: Before performing the Delay Time adjustments, you must first have completed the Loudspeaker Size and Level adjustments.

- Measure the distances of the Loudspeakers used in the Home Theater System, from the Listening/Viewing Area to each Loudspeaker to within the nearest foot or tenth of a meter.

- Use the Down▼ directional Push-button to select DELAY TIME followed by pressing the SELECT Push-button on the Remote Control. Refer to figure 46.

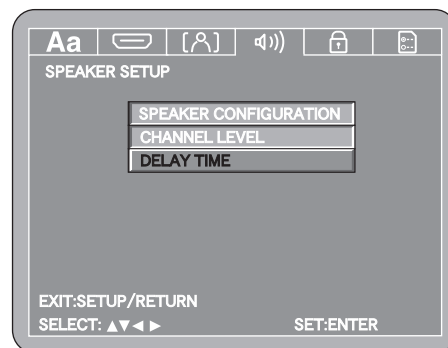

Figure 46

- Use the Down▼ directional Push-button to select DISTANCE then press the Right► or Left◀ directional Push-buttons to select the desired measurement increments, either Feet or Meters. Refer to figure 47.

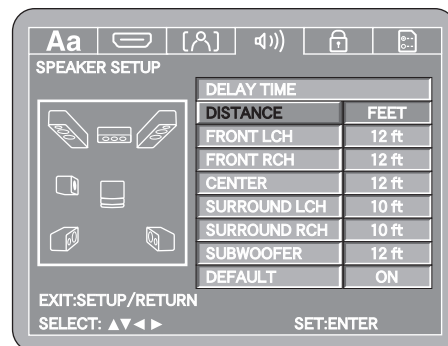

Figure 47

- Use the Down▼ directional Push-button to select FRONT LCH then use the Right► or Left◀ directional Push-buttons to enter in the distance of the Loudspeaker from the Listening/Viewing Area. Refer to figure 48.

Note: To reset all the Loudspeaker Delay Time settings

to the default settings first select DEFAULT menu choice and then press the SELECT Push-button.

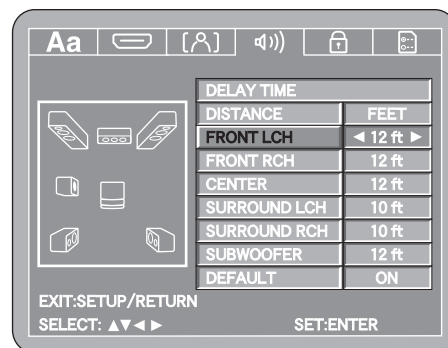

Figure 48

- Enter in the distances for the remaining Loudspeakers.

- When all the Loudspeaker distances are entered, press the RTRN (Return) Push-button twice to return to the Digital Interface Setup.
- Next continue to the DIGIT OUTPUT Settings. If no other changes are to be made in Setup Mode at this time, exit by pressing the RTRN (Return) Push-button.

Note: The SETUP Push-button may be also pressed to exit the setup mode.

Digital Output

The default setting for the Coaxial and Optical Digital Audio Outputs is to pass through the selected Dolby Digital or DTS Digital Bitstream Signals for external decoding. The optional setting is for sending out a two channel PCM Digital Signal.

- Press the SETUP Push-button on the supplied Remote Control to access the On-Screen Language Setup Menu. Then press the Right▶ directional Push-button to select the Audio Setup Tab.

Note: If there is a Disc playing in the MVP871, press the STOP Push-button twice before pressing the SETUP Push-button.

- Use the Down▼ directional Push-button followed by the Right▶ directional Push-button on the Remote Control to select DIGITAL OUTPUT. Refer to figure 49.
- Use the Right▶ directional Push-button followed by the Up▲ or Down▼ directional Push-buttons to select PCM. Then press the SELECT Push-button.

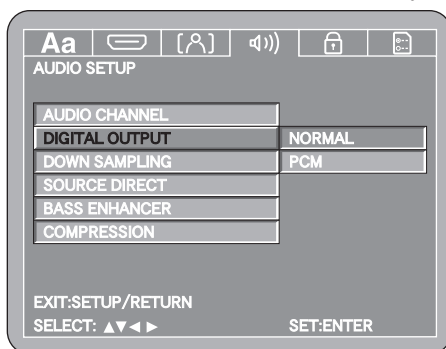

Figure 49

- Next continue to the DOWN SAMPLING Setup Menu item. If no other changes are to be made in Setup Mode at this time, exit by pressing the RTRN (Return) Push-button.

Note: The SETUP Push-button may be also pressed to exit the setup mode.

Down Sampling

The default setting for Down Sampling is Off. When a non-copyrighted DVD disc without protection is played the MVP871 will pass through the 192kHz or 176.4kHz signal. If the DVD disc is copyright protected those signals would not become available, however the MVP871 will down sample the signal to 48kHz. To activate the down sampling feature select On for Down Sampling.

- Press the SETUP Push-button on the supplied Remote Control to access the On-Screen Language Setup Menu. Then press the Right▶ directional Push-button to select the Audio Setup Tab.

Note: If there is a Disc playing in the MVP871, press the STOP Push-button twice before pressing the SETUP Push-button.

- Use the Down▼ directional Push-button followed by the Right▶ directional Push-button on the Remote Control to select DOWN SAMPLING. Refer to figure 50.

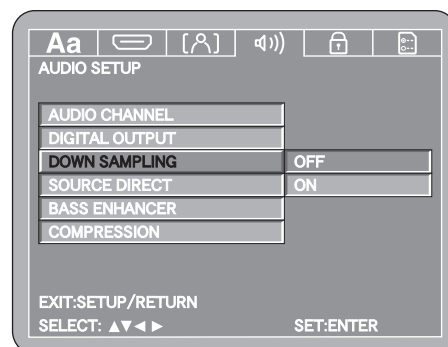

Figure 50

- Use the Right▶ directional Push-button followed by the Up▲ or Down▼ directional Push-buttons to select ON. Then press the SELECT Push-button.
- Next continue to the SOURCE DIRECT Setup Menu item. If no other changes are to be made in Setup Mode at this time, exit by pressing the RTRN (Return) Push-button.

Note: The SETUP Push-button may be also pressed to exit the setup mode.

Source Direct

The MVP871 Source Direct Feature, when active, reproduces the full range of sound when playing SACD and DTS Music Discs. The default setting for Source Direct is Off. When activated, the Loudspeaker Configuration Settings previously made are overridden. The Front and Surround Loudspeakers are configured as Large with the Subwoofer set to On. The High Frequency response is extended to 50kHz or 100kHz depending on the choice made. To activate the Source Direct feature perform the following:

Note: If the Front and Surround Loudspeakers in your system are considered small (refer to additional information on page 30, Loudspeaker Size Configuration) do not activate Source Direct as distortion and/or damage could occur.

- Press the SETUP Push-button on the supplied Remote Control to access the On-Screen Language Setup Menu. Then press the Right▶ directional Push-button to select the Audio Setup Tab.

Note: If there is a Disc playing in the MVP871, press the STOP Push-button twice before pressing the SETUP Push-button.

How to Set the Audio, con't

- Use the Down▼ directional Push-button followed by the Right► directional Push-button on the Remote Control to select SOURCE DIRECT. Refer to figure 51.
- Use the Right► directional Push-button followed by the Up▲ or Down▼ directional Push-buttons to select either the 50kHz or 100kHz setting. Then press the SELECT Push-button.
- Next continue to the BASS ENHANCER Setup Menu item. If no other changes are to be made in Setup Mode at this time, exit by pressing the RTRN (Return) Push-button.

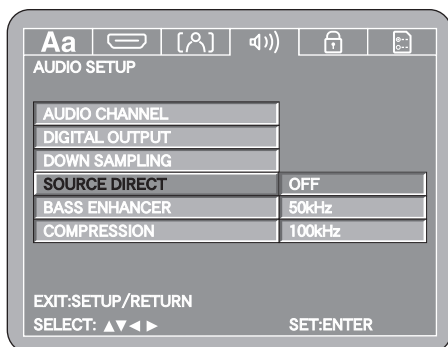

Figure 51

- Use the Right► directional Push-button followed by the Up▲ or Down▼ directional Push-buttons to select the ON setting. Then press the SELECT Push-button.
- Next continue to the COMPRESSION Setup Menu item. If no other changes are to be made in Setup Mode at this time, exit by pressing the RTRN (Return) Push-button.

Note: The SETUP Push-button may be also pressed to exit the setup mode.

Compression

Watching a movie with a wide dynamic range late at night could disturb others not viewing the movie. The MVP871 Compression feature reduces the dynamic range, allowing enjoyment of the movie without disturbing others. Select the Dolby Digital Sound Track (DVD Disc Menus) and to activate the Compression feature perform the following:

- Press the SETUP Push-button on the supplied Remote Control to access the On-Screen Language Setup Menu. Then press the Right► directional Push-button to select the Audio Setup Tab.

Note: If there is a Disc playing in the MVP871, press the STOP Push-button twice before pressing the SETUP Push-button.

- Use the Down▼ directional Push-button followed by the Right► directional Push-button on the Remote Control to select COMPRESSION. Refer to figure 53.

- Use the Right► directional Push-button followed by the Up▲ or Down▼ directional Push-buttons to select the ON setting. Then press the SELECT Push-button.

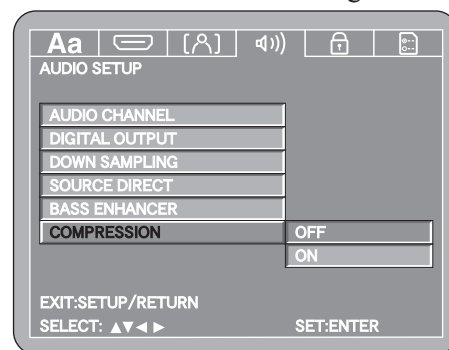

Figure 53

- Next continue to the RATINGS Setup Menu item. If no other changes are to be made in Setup Mode at this time, exit by pressing the RTRN (Return) Push-button.

Note: The SETUP Push-button may be also pressed to exit the setup mode.

Bass Enhancer

The MVP871 Bass Enhancer redirects low frequency sounds to the Subwoofer when a two channel audio source or other source without Low Frequency Effects (LFE) is playing. The Subwoofer needs to be active, refer to Loudspeaker Configuration on page 30. The default setting for Bass Enhancer is Off, to activate the Bass Enhancer Direct feature perform the following:

- Press the SETUP Push-button on the supplied Remote Control to access the On-Screen Language Setup Menu. Then press the Right► directional Push-button to select the Audio Setup Tab.

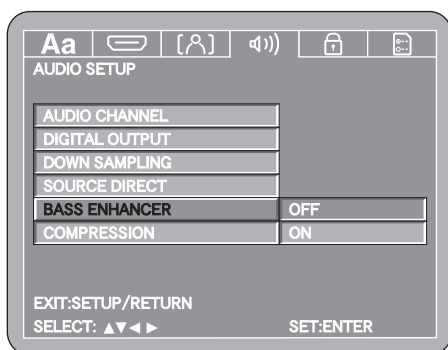

Figure 52

Note: If there is a Disc playing in the MVP871, press the STOP Push-button twice before pressing the SETUP Push-button.

- Use the Down▼ directional Push-button followed by the Right► directional Push-button on the Remote Control to select BASS ENHANCER. Refer to figure 52.

How to Set the Ratings

Rating Level

Some DVD Movie discs have encoded rating levels that allow setting the MVP871 to prevent children from viewing inappropriate movies in your absence. A password protected lock function, set by you, determines the rating limit for disc playback. In the example below the default setting of No Limit Rating Level will be changed to Level 3.

Note: A Rating Level of 8 allows viewing of all DVD Movies and a Level of 1 plays movies suitable for children. It is advisable to write down the password for future reference, as once a password has been entered it will stay in effect until removed or changed.

1. Press the SETUP Push-button on the supplied Remote Control to access the Language Setup Menu. Then press the Right► directional Push-button to select the Ratings Menu Icon Tab. Refer to figures 54 and 55.

Note: If there is a Disc playing in the MVP871 press the STOP Push-button twice before pressing the SETUP Push-button.

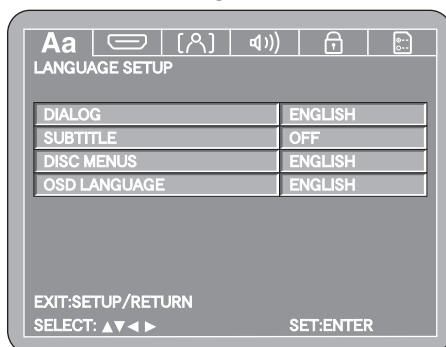

Figure 54

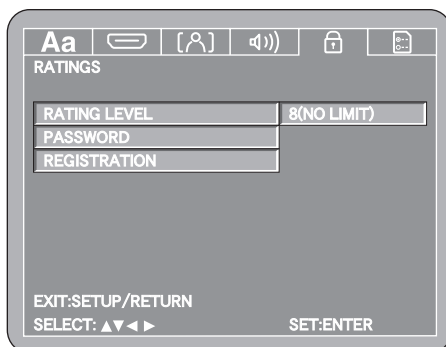

Figure 55

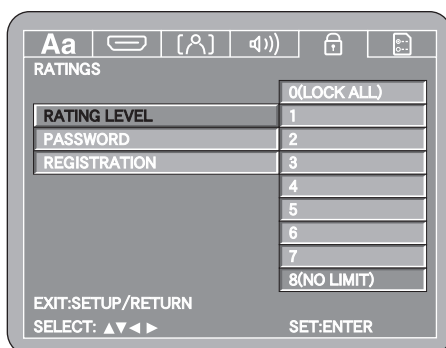

Figure 56

2. Use the Down▼ directional Push-button on the Remote Control to select the RATING LEVEL Menu. Refer to figure 56.
3. Select the desired rating level of 3 by using the Up▲ or Down▼ directional Push-buttons followed by the SELECT Push-button.

3. Using the NUMERIC Push-buttons on the Remote Control, enter the default password “0000” followed by SELECT Pushbutton. Refer to figure 57.
4. Return to the Rating Menu by pressing the Up▲ directional Push-button.
6. Next continue to the PASSWORD Settings. If no other changes are to be made in Setup Mode at this time, exit by pressing the RTRN (Return) Push-button.

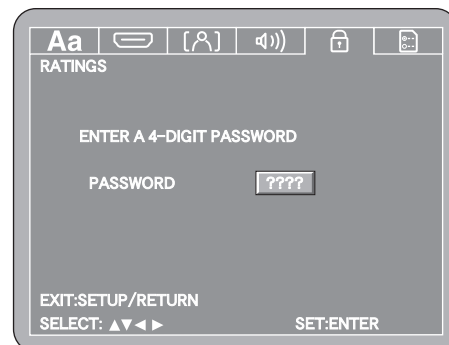

Figure 57

Note: The SETUP Push-button may be also pressed to exit the setup mode.

Password

The Password of 0000 used in the previous Rating Level example or any other previously entered password may be changed at any time. To change the current password perform the following steps:

1. Press the SETUP Push-button on the supplied Remote Control to access the Language Setup Menu. Then press the Right► directional Push-button to select the Ratings Menu Icon Tab. Refer to figure 55.
2. Use the Down▼ directional Push-button on the Remote Control to select the PASSWORD Menu. Refer to figure 58.

Note: If there is a Disc playing in the MVP871 press the STOP Push-button twice before pressing the SETUP Push-button.

3. Use the Right► directional Push-button followed by the SELECT Push-button. Then enter using the Numeric Push-buttons on the Remote Control the current password “0000”, followed by the SELECT Push-button. Refer to figure 59 on the next page.

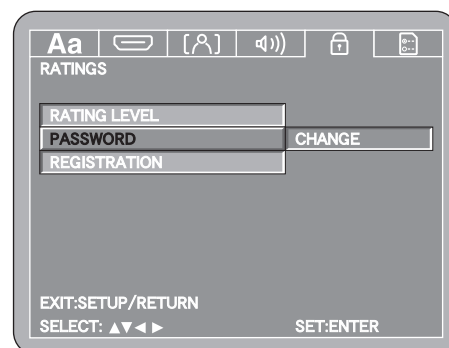

Figure 58

How to Set the Ratings

4. Again, using the NUMERIC Push-buttons on the Remote Control enter the new password to confirm it. Then press the SELECT Push-button. Refer to figure 60.

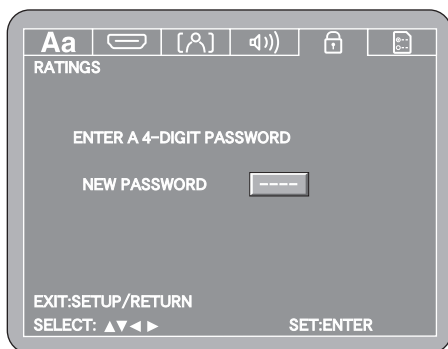

Figure 59

5. Press the SELECT Push-button.
6. Return to the Ratings Menu by pressing the Up▲ directional Push-button.

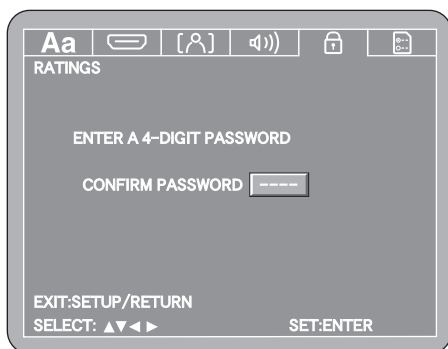

Figure 60

7. Next continue to the REGISTRATION Menu. If no other changes are to be made in Setup Mode at this time, exit by pressing the Down▼ directional Push-button to select the EXIT SETUP menu choice followed by the SELECT Push-button and the MVP871 will return to normal operation.

Note: The SETUP Push-button may be also pressed to exit the setup mode.

Registration

The eight digit Registration Code is used when leasing or purchasing DivX Video On Demand (VOD) format files for additional information use the Internet and go to <http://www.divx.com/vod>. To view the Registration Code perform the following steps:

1. Press the SETUP Push-button on the supplied Remote Control to access the Language Setup Menu. Then press the Right▶ directional Push-button to select the Ratings Menu Icon Tab.

Note: If there is a Disc playing in the MVP871 press the STOP Push-button twice before pressing the SETUP Push-button.

2. Use the Down▼ directional Push-button on the Remote Control to select the REGISTRATION Menu with the eight digit code. Refer to figures 61 and 62.
3. Return to the Ratings Menu by pressing the Up▲ directional Push-button.

4. Next continue to the OTHER SETUP Menu. If no other changes are to be made in Setup Mode at this time, exit by pressing the Down▼ directional Push-button to select the EXIT SETUP menu choice followed by the SELECT Push-button and the MVP871 will return to normal operation.

Note: The SETUP Push-button

may be also pressed to exit the setup mode.

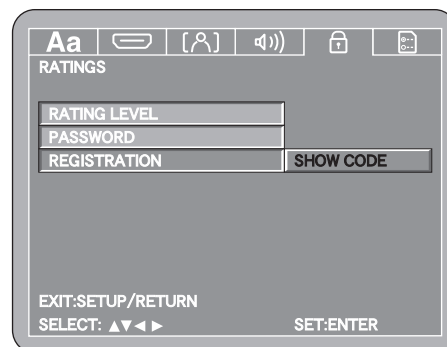

Figure 61

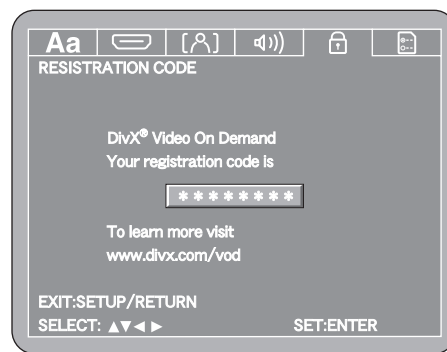

Figure 62

How to Set the Other Setup

Player Mode

Some DVD-Audio Discs offer additional different playback features such as viewing photo gallery, song lyrics and/or videos. Depending on the disc, some of features may only be available when the MVP871 Player Mode is set to the Video Mode. To change from the default setting of Audio Player Mode to Video Player Mode, perform the following steps:

1. Press the SETUP Push-button on the supplied Remote Control to access the On-Screen Language Setup Menu. Then press the Right▶ directional Push-button to select the OTHER Setup Menu Icon Tab. Refer to figures 63 and 64.

Note: If there is a Disc playing in the MVP871 press the STOP Push-button twice before pressing the SETUP Push-button.

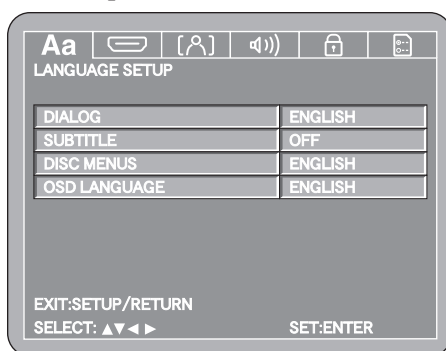

Figure 63

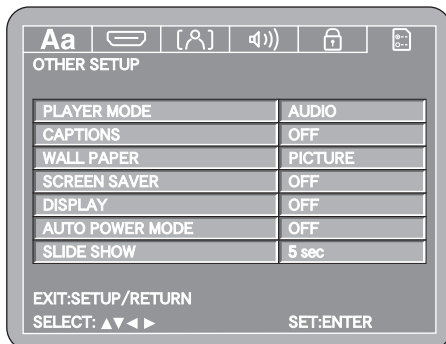

Figure 64

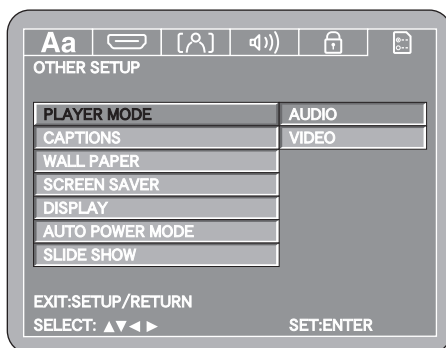

Figure 65

2. Use the Down▼ directional Push-button on the Remote Control to select the PLAYER MODE Menu. Refer to figure 65.
3. To change from the default setting use the Right▶ directional Push-button followed by Up▲ or Down▼ directional Push-buttons and then press the SELECT Push-button.

Note: The title of the icon button-bar will change color

from yellow (the cursor color) to blue indicating the selected item.

4. Return to the Video Setup Menu by pressing the Left◀ followed by the Up▲ directional Push-buttons.
5. Next continue to the CAPTIONS Settings. If no other changes are to be made in Setup Mode at this time, exit by pressing the RTRN (Return) Push-button.

Note: The SETUP Push-button may be also pressed to exit the setup mode.

Captions

Some DVD Discs offer On-screen captions of the dialog, adding enjoyment to the movie. To activate the Caption feature perform the following steps:

1. Press the SETUP Push-button on the supplied Remote Control to access the On-Screen Language Setup Menu. Then press the Right▶ directional Push-button to select the OTHER Setup Menu Icon Tab.

Note: If there is a Disc playing in the MVP871 press the STOP Push-button twice before pressing the SETUP Push-button.

2. Use the Down▼ directional Push-button on the Remote Control to select the CAPTIONS Menu. Refer to figure 66.
3. To change from the default setting of OFF press the Right▶ directional Push-button and the Up▲ or Down▼ directional Push-buttons to select ON followed by the SELECT Push-button.

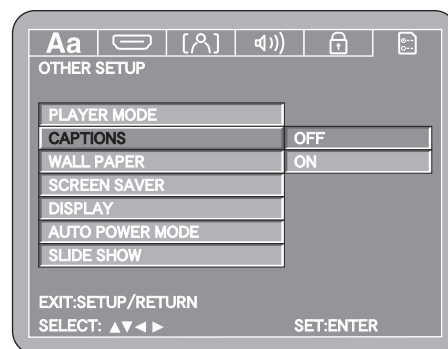

Figure 66

Note: The title of the icon button-bar will change color from yellow (the cursor color) to blue indicating the selected item.

4. Return to the Other Setup Menu by pressing the Left◀ followed by the Up▲ directional Push-buttons.
5. Next continue to the WALL PAPER Settings. If no other changes are to be made in Setup Mode at this time, exit by pressing the RTRN (Return) Push-button.

Note: The SETUP Push-button may be also pressed to exit the setup mode.

Wall Paper

When the MVP871 is in the Stop Mode there is uniform video background. To change from the default color of blue perform the following steps:

1. Press the SETUP Push-button on the supplied Remote

How to Set the Other Setup

Control to access the On-Screen Language Setup Menu. Then press the Right► directional Push-button to select the OTHER Setup Menu Icon Tab.

Note: If there is a Disc playing in the MVP871 press the STOP Push-button twice before pressing the SETUP Push-button.

- Use the Down▼ directional Push-button on the Remote Control to select the WALL PAPER Menu. Refer to figure 67.

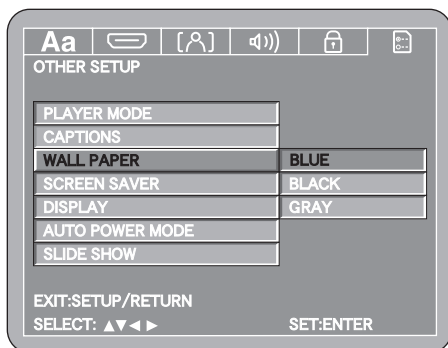

Figure 67

- To change from the default setting press the Right► directional Push-button and the Up▲ or Down▼ directional Push-buttons to select the desired color followed by the SELECT Push-button.

Note: The title of the icon button-bar will change color from yellow (the cursor color) to blue indicating the selected item.

- Return to the Other Setup Menu by pressing the Left◀ followed by the Up▲ directional Push-buttons.
- Next continue to the SCREEN SAVER Settings. If no other changes are to be made in Setup Mode at this time, exit by pressing the RTRN (Return) Push-button.

Note: The SETUP Push-button may be also pressed to exit the setup mode.

Screen Saver

When the Screen Saver Mode is active, the MVP871 will display a randomly placed DVD Audio/Video Icon on the screen approximately 5 minutes after the transport has been Stopped or Paused. To activate the screen saver perform the following steps:

- Press the SETUP Push-button on the supplied Remote Control to access the On-Screen Language Setup Menu. Then press the Right► directional Push-button to select the OTHER Setup Menu Icon Tab.

Note: If there is a Disc playing in the MVP871 press the STOP Push-button twice before pressing the SETUP Push-button.

- Use the Down▼ directional Push-button on the Remote Control to select the SCREEN SAVER Menu. Refer to figure 68.
- To change from the default setting press the Right► directional Push-button and the Up▲ or Down▼ directional Push-buttons to select ON followed by the SELECT Push-button.

Note: The title of the icon button-bar will change color from yellow (the cursor color) to blue indicating the selected item.

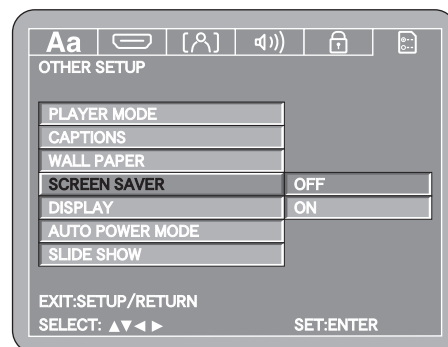

Figure 68

- Return to the Other Setup Menu by pressing the Left◀ followed by the Up▲ directional Push-buttons.
- Next continue to the DISPLAY Settings. If no other changes are to be made in Setup Mode at this time, exit by pressing the RTRN (Return) Push-button.

Note: The SETUP Push-button may be also pressed to exit the setup mode.

Display

The Display On/Off feature is not used in the MVP871.

- Next continue to the AUTO POWER MODE Settings. If no other changes are to be made in Setup Mode at this time, exit by pressing the RTRN (Return) Push-button.

Note: The SETUP Push-button may be also pressed to exit the setup mode.

Auto Power Mode

The MVP871 has a feature to switch itself Off 30 minutes after a disc has stopped playing (the stop mode). To activate the Auto Power Mode feature perform the following steps:

- Press the SETUP Push-button on the supplied Remote Control to access the On-Screen Language Setup Menu. Then press the Right► directional Push-button to select the OTHER Setup Menu Icon Tab.

Note: If there is a Disc playing in the MVP871 press the STOP Push-button twice before pressing the SETUP Push-button.

- Use the Down▼ directional Push-button on the Remote Control to select the AUTO POWER MODE Menu. Refer to figure 69.
- To change from the default setting of OFF use the Up▲ or Down▼ directional Push-buttons to select ON followed by the SELECT Push-button.

Note: The title of the icon button-bar will change color from yellow (the cursor color) to green indicating the selected item.

- Return to the Other Setup Menu by pressing the Up▲ directional Push-button.

- Next continue to the SLIDE SHOW Settings. If no other changes are to be made in Setup Mode at this time, exit by pressing the RTRN (Return) Push-button.

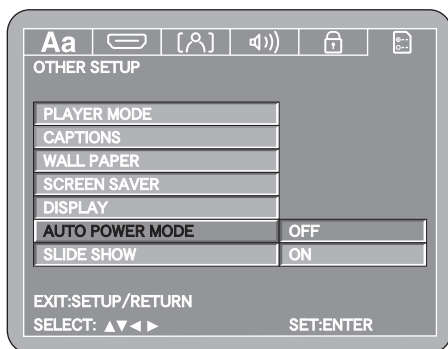

Figure 69

Note: The SETUP Push-button may be also pressed to exit the setup mode.

Slide Show

The MVP871 has a feature to view photos from a disc and the interval time between photos is adjustable from 5 to 15 seconds. To change the interval time perform the following steps:

- Press the SETUP Push-button on the supplied Remote Control to access the On-Screen Language Setup Menu. Then press the Right▶ directional Push-button to select the OTHER Setup Menu Icon Tab.

Note: If there is a Disc playing in the MVP871 press the STOP Push-button twice before pressing the SETUP Push-button.

- Use the Down▼ directional Push-button on the Remote Control to select the SLIDE SHOW Menu. Refer to figure 70.

- To change from the default setting of 5 seconds press the Right▶ directional Push-button and then the Up▲ or Down▼ directional Push-buttons to select

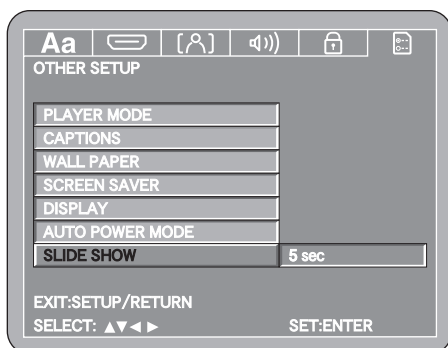

Figure 70

the desired time followed by the SELECT Push-button.

Note: The title of the icon button-bar will change color from yellow (the cursor color) to blue indicating the selected item.

- Return to the Other Setup Menu by pressing the Up▲ directional Push-button.
- If no other changes are to be made in Setup Mode at this time, exit by pressing the RTRN (Return) Push-button.

Note: The SETUP Push-button may be also pressed to exit the setup mode.

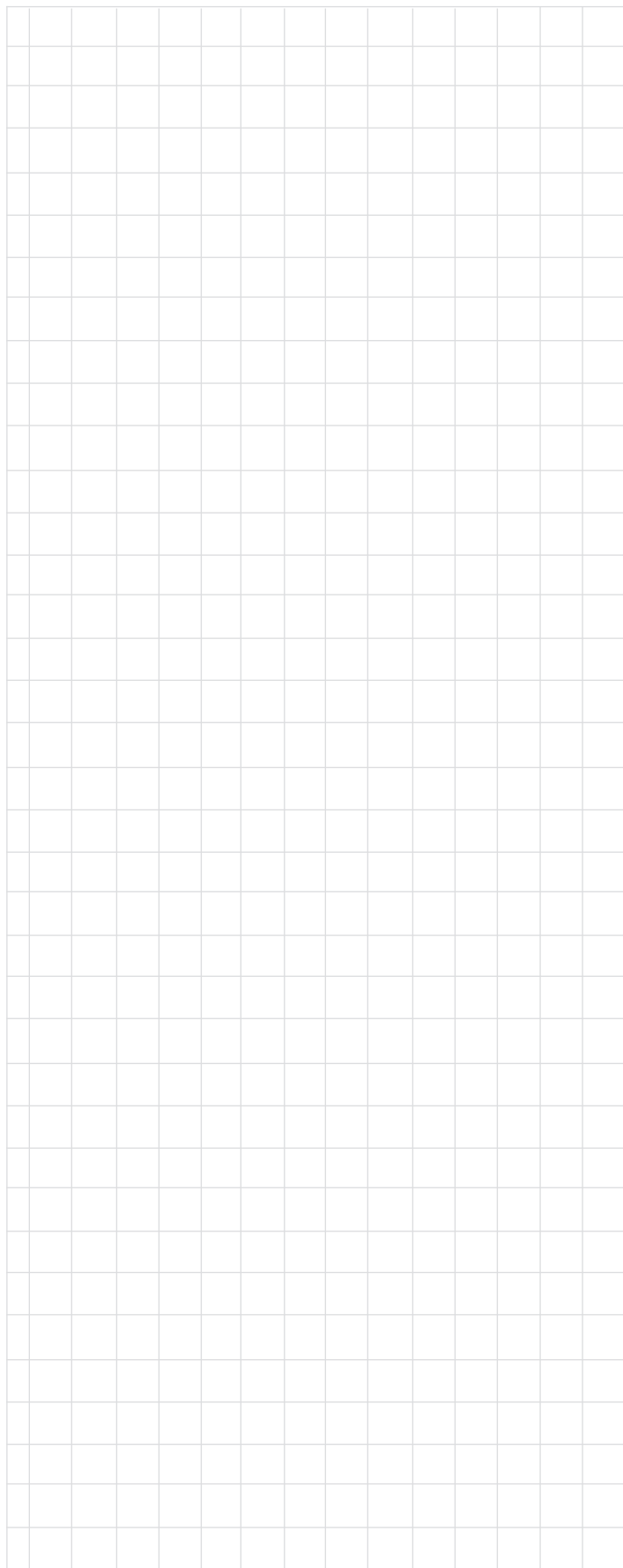



How to Operate the MVP871

Your McIntosh MVP871 has been configured for default operating settings that will allow you to immediately enjoy superb video and high fidelity audio from a wide variety of discs. If you wish to make changes to the default settings, a Setup feature is provided to customize the operating settings using On Screen Menus (refer to the Setup instructions in this manual on page 18). Most operations that can be performed with the Front Panel Push-buttons can also be performed with the Remote Control.

Note: Some of the MVP871 operating functions such as Disc Languages, Video Angle or Menu Language are active only if the function is supported by data encoded on the disc.

Power On

The Red LED above the STANDBY/ON switch lights to indicate the MVP871 is in Standby mode. To Switch ON the MVP871, press the STANDBY/ON Push-button on the Front Panel or on the Remote Control either the PWR(Power) or POWER ON Push-button. Refer to figures 71 and 72.

Notes: When AC Power is initially applied to the MVP871 the unit will momentarily switch On and then go into the Standby Mode. If a disc has already been loaded in the MVP871, just press the PLAY Push-button on the Front Panel or Remote Control and the player will switch On and the disc will start playing.

How to Load a DVD, SACD or CD Disc

1. Press the OPEN/CLOSE Push-button. The disc tray will slide out allowing a disc to be loaded. Refer to figures 71 and 73.

Note: When the player is in Standby Mode, the MVP871 Power will automatically Switch-On when the OPEN/CLOSE Push-button is pressed.

2. Press the OPEN/CLOSE Push-button and the disc tray will close. If the tray contains a DVD disc, it will start

to play without pressing the PLAY Push-button. When a SACD or CD disc is in the tray, the disc's Table of Contents (number of tracks and total playing time) will be indicated on the Front Panel Alphanumeric Display. Press the PLAY Push-button for playback of a CD.

Note: If a CD is placed in the tray and the PLAY Push-button is pressed, instead of the OPEN/CLOSE Push-button, the tray will close and the disc will start playing the first track.

How to Play a DVD Disc

With a disc already loaded into the MVP871, press the PLAY▶ Push-button on the Front Panel of the MVP871 or the Remote Control. Refer to figures 71 and 72.

Note: When a DVD Video or Audio Disc is first started, the Disc's On-Screen Menu will usually appear allowing for the choice of selections and various Audio/Video Playback Parameters.

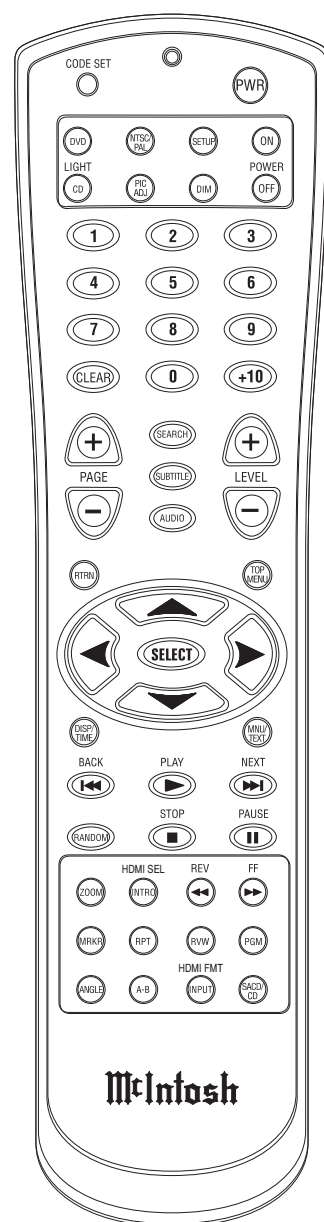

Figure 72

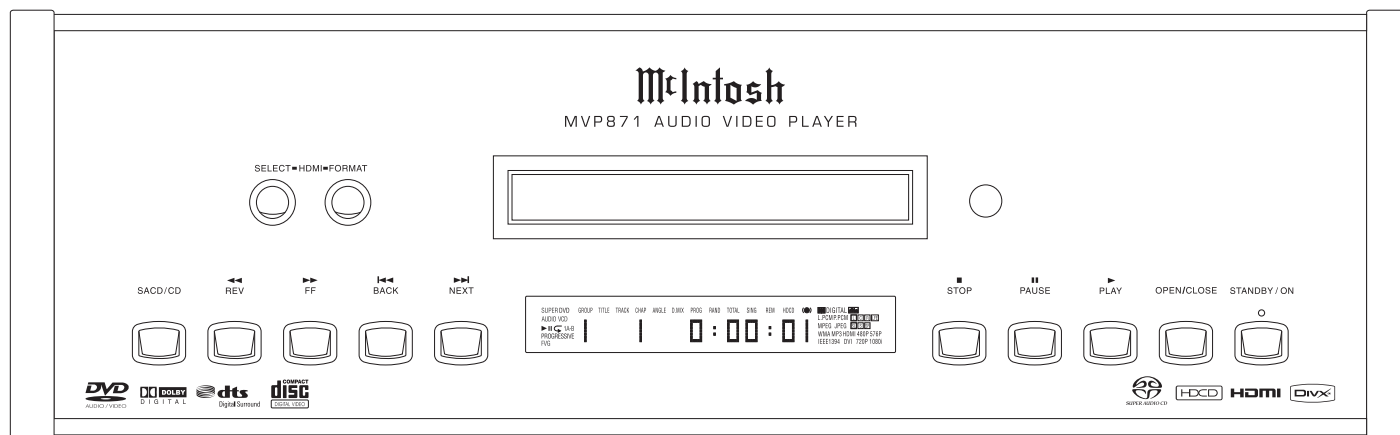

Figure 71

How to Play a SACD Disc

With a disc already loaded into the MVP871, press the PLAY▶ Push-button on the Front Panel of the MVP871 or Remote Control. The Disc will start playing the first selection of the SACD Layer; this could be either the Multi-channel Tracks or 2- Channel Tracks depending on the disc contents.

To change from the default Multichannel Tracks to either SACD 2-Channel or CD Tracks, press the SACD/CD Push-button on the Front Panel or Remote Control, until the desired track's format title appears (Multi, Stereo or CD) on the alphanumeric display. Refer to figures 71, 72 and 73.

Note: The MVP871 remembers the layer selected (SACD Multichannel, SACD Stereo or CD) from the last SACD Disc played. The next SACD played will start with the same layer selected.

The Player will load the Table of Contents (Number of tracks and Total Playing Time) at this time. To start playing the desired format press the PLAY Push-button.

Note: Changing between the formats can be accomplished at any time by performing the above procedure.

How to Play a CD Disc

With a disc already loaded into the MVP871, press the PLAY▶ Push-button on the Front Panel of the MVP871 or Remote Control. Refer to figures 71 and 72.

How to Pause a Disc

This feature allows the temporary stopping of disc playback. Refer to figures 71, 72 and 73.

1. When playing a Disc, press the PAUSE II Push-button to temporarily stop playback.

Note: After the Pause Feature is activated, with a DVD-Video Disc in the MVP871, each additional press of the PAUSE II Push-button will permit the video to advance one frame at a time.

2. Press the PLAY▶ Push-button to cancel pause and resume playing the disc.

DVD-Video Rapid Frame Advance

The MVP871 allows for rapid scanning of DVD Video Frames both forward or backward directions at different speeds.

1. When a disc is playing, press the PAUSE II Push-button to stop playback.
2. Press the FF(Fast Forward)▶▶ or REV(Reverse)◀◀ Push-button to activate the Rapid Frame Advance.

Note: If the FF(Fast Forward) or REV(Reverse) Push-button is pressed several times, the speed of the Frame Advance will increase. An On-Screen Icon will appear during the Rapid Frame Advance Mode indicating the advance speed.

3. To cancel the Rapid Frame Advance Feature press the PLAY▶ Push-button.

Back Track/Chapter

Advance back to the beginning of the Track/Chapter currently playing by momentarily pressing the BACK◀◀ Push-button on the MVP871. Repeated momentary presses of the BACK◀◀ Push-button will allow for rapid selection of the desired previous Tracks/Chapters.

Next Track/Chapter

For each momentary press of the NEXT▶▶ Push-button the MVP871 will advance to the next Track/Chapter. Repeated momentary presses of the NEXT▶▶ Push-button will allow for rapid selection of the desired Track/Chapter.

Fast Forward or Reverse

Press and release the FF (Fast Forward)▶▶ or REV (Reverse)◀◀ Push-button to search back and forth rapidly through a Track/Chapter on a disc at 2 times normal speed. An On-Screen Icon will appear on the screen and the audio will be muted. If the FF (Fast Forward)▶▶ or REV (Reverse)◀◀ Push-button is pressed and released several times, the speed will increase to a maximum of 5 times normal speed. To return to normal playback press the PLAY▶ Push-button.

Stop Mode

Press the STOP■ push-button once to stop disc playback. Press PLAY▶ and the disc will start playing again from the disc time where Stop was pressed. Press STOP■ twice for a complete stop and return to the beginning of a disc.

Note: With a DVD Disc, Video information from the disc will be muted during the Stop Mode, but will resume when the PLAY▶ Push-button is pressed and playback starts. Using the Pause Push-button instead of the Stop Push-button, will retain the video on the screen for viewing. It is not advisable to keep the MVP871 in the Stop Mode (one push-button press) for any length of time as the Laser Transport is still active.

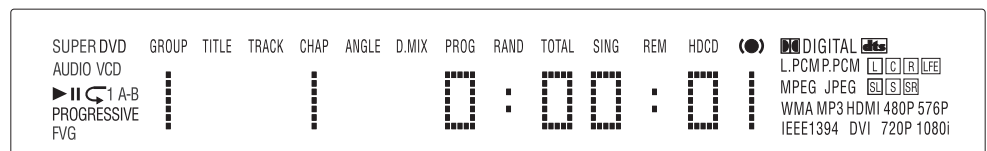

Figure 73

How to Operate the MVP871, con't

On Screen Icon Display

There are On-Screen Icons available to indicate the current audio transport operating conditions and some also provide the ability to make changes to the disc currently being played. These On-Screen Icons are accessible by pressing the DISP/TIME, AUDIO or SEARCH Push-button on the supplied Remote Control. For each of the disc types played there is at least one On-Screen Icon. If there are more than one On-Screen Icons for a given disc type, they are accessed by additional presses of the DISP/TIME Push-button. Refer to figures 74 and 75.

Once the On-Screen Icon appears, changes to items such as the Track Playing, the Chapter Playing, the Group Playing, the Elapsed Time into the disc or the

Audio Mode, etc. may be accomplished. The highlighted item or another item can be selected by using the DIRECTIONAL, SELECT AND NUMERIC Push-buttons on the Remote Control. After the desired changes have been made, the last press of the DISP/TIME, AUDIO or SEARCH Push-button will switch off the On-Screen Icon.



Figure 74



Figure 75

DVD-Video Direct Title Selection

The MVP871 Front Panel Display indicates the Disc Title currently playing. Use the Remote Control NUMERIC Push-button(s) to enter the desired Title Number.

Note: The desired disc Title may also be selected by using the Search Function. Press the SEARCH Push-button on the Remote Control until the Title On-Screen Icon appears, then use the NUMERIC Push-buttons to select the desired Title.

DVD-Video Direct Chapter Selection

The MVP871 Front Panel Display indicates the Disc Chapter currently playing. Press the SEARCH Push-button on the Remote Control until the Chapter On-Screen Icon appears then use the NUMERIC Push-buttons to select the desired Chapter.

DVD-Audio Direct Track Selection

The MVP871 Front Panel Display indicates the Disc Track currently playing. Use the Remote Control NUMERIC Push-button(s) to enter the desired Track Number.

Note: The desired disc Tracks may also be selected by using the On-Screen Icon. Press the SEARCH Push-button on the Remote Control and then NUMERIC Push-buttons.

DVD-Audio Group/Track Selection

To select a desired Group from a DVD-Audio Disc on the MVP871 press the DISP/TIME Push-button to access the On Screen Icon. Press the Right▶ or Left◀ directional Push-buttons to highlight either the Group or Track On-Screen Icon. Use the Remote Control NUMERIC Push-button(s) to enter the desired Track Number followed by the SELECT Push-button.

SACD and CD Direct Track Selection

The MVP871 Front Panel Display indicates the Disc Track currently playing. Use the Remote Control NUMERIC Push-button(s) to enter the desired Track Number.

Note: The desired disc Tracks may also be selected by using the On-Screen Icon. Press the SEARCH Push-button on the Remote Control and then NUMERIC Push-buttons.

How to Set and Activate Markers

This feature allows establishing up to eight different starting places on a disc where playback can start, other than at the beginning of the disc.

1. Press the MRKR (Marker) Push-button and the Marker On-Screen Icon will appear. Refer to figure 76.
2. Press the SELECT Push-button to enter the first starting location. The highlighted dot on the left side will change to a number 1.
3. Press the Right▶ di-



Figure 76

rectional Push-buttons to highlight the second dot from the end of the left side. Press the SELECT Push-button to enter the second starting location.

4. Enter a third starting point if desired. Up to eight Markers can be stored in memory.

Note: If you wish to erase a MARKER, use the Left◀ or Right▶ directional Push-buttons to select the desired Marker and press the CLEAR push-button.

To start playback from a desired Marker Location perform the following steps:

1. Press the MRKR (Marker) Push-button to select the Marker On-Screen Icon, if not already displayed On-Screen.
2. Using the Left◀ or Right▶ directional Push-buttons to select the desired Marker Starting Location, then press the SELECT Push-button.
3. Press the MRKR (Marker) Push-button to exit the Marker On-Screen Icon.

DVD-Video Repeat

This allows repeating a DVD Chapter or the Title (the entire movie) on a continuous basis. Refer to figure 77.

1. Start playing the disc or the part of the disc you desire to have repeated.
2. Press the RPT (Repeat) Push-button once to activate the Chapter Repeat (1); press the RPT Push-button twice to activate the Title Repeat (All). Refer to the On-Screen Text Message.
3. To cancel the previously selected Repeat Mode, press the RPT (Repeat) Push-button until the On-Screen Text Message indicates “REPEAT Off” or the word “REPEAT” in the lower right hand corner of the Front Panel Alphanumeric Display is extinguished.

DVD-Audio Repeat

This allows repeating a DVD Track or the Group (a selection of tracks) on a continuous basis. Refer to figure 77.

1. Start playing the disc or the part of the disc you desire to have repeated.
2. Press the RPT (Repeat) Push-button once to activate the Track Repeat (1); press the RPT Push-button twice to activate the Group Repeat (All). Refer to the On-Screen Text Message.
3. To cancel the previously selected Repeat Mode, press the RPT (Repeat) Push-button until the On-Screen Text Message indicates “REPEAT Off”.

SACD or CD Repeat

This allows repeating a SACD/CD Track or the Disc on a continuous basis. Refer to figure 77.

1. Start playing the disc or the part of the disc you desire to have repeated.
2. Press the RPT (Repeat) Push-button once to activate the Track Repeat (1); press the RPT Push-button twice to activate the Disc Repeat (All). Refer to the On-Screen Text.
3. To cancel the previously selected Repeat Mode, press the RPT (Repeat) Push-button until the On-Screen Text message indicates “REPEAT Off” or the word “REPEAT” in the lower right hand corner of the Front Panel Alphanumeric Display is extinguished.

Disc A-B Repeat

This feature allows the repeating of a specific disc segment on a continuous basis. Refer to figure 77.

1. Start playing the part of the disc you desire to have repeated.
2. Press the A-B Push-button once to enter the A (starting point) and press the same push-button a second time B (ending point). Refer to the On-Screen Text.
3. To cancel A-B REPEAT function press the A-B Push-button once again. The On-Screen Text message indicates “A to B CANCELED”.

Random Playback

This feature allows for listening to Tracks of a SACD or CD Disc in a Random Order. It also allows for the playback of Tracks in a Group on a DVD-Audio Disc in random order. Refer to figure 77.

Note: The MVP871 must be in STOP Mode with the Disc Loaded (Table of Contents) read first before the Random Playback Mode Feature can be activated.

1. After the Table of Contents has been read with the transport in the full stop mode (press the Stop Push-button Twice), press the RANDOM Push-button.
2. Press the PLAY▶ Push-button to start Random Playback, after all the tracks have been played the MVP871 will stop.
3. To cancel the Random Playback function first press the STOP Push-button twice followed by RANDOM Push-button.

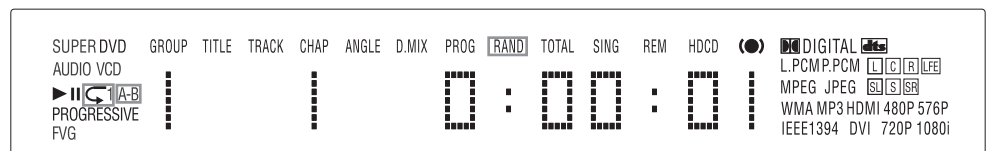

Figure 77

How to Operate the MVP871, con't

SACD and CD Disc Program Playback Mode

This feature allows for the playback of Tracks of SACD and CD Discs in the desired order. Refer to figure 78.

Notes: 1. The MVP871 must be in full STOP Mode (two presses of the STOP

Push-button) with the Disc Table of Contents (TOC) read before the Program Playback Mode Feature can be activated.

PROGRAM		TRACK	TRACK
1	8	11	
2	6	12	
3	3	13	
4	1	14	
5	11	15	
6	2	16	
7	15	17	
8		18	
9		19	
10		20	

PRESS PLAY TO START

Figure 78

2. When programming Hybrid SACD Discs, first choose the format (Multichannel, Stereo or CD) so the correct TOC can be read as some discs have different selections.

1. Press the PGM (Program) Push-button to access the On-Screen Program Mode.

Note: It is possible to enter a Program using just the Front Panel Alphanumeric Display; however the On-Screen Icon Display allows viewing of the whole program at one time.

2. Using the Numeric Push-buttons enter the desired Track Selection for the first Program Step.

Note: The MVP871 automatically stores into memory each of the program steps as they are entered.

3. In a similar manner, enter the remaining desired Tracks.

Note: The CLEAR Push-button may be used to delete a selected Program Step.

4. To start playback of the just entered program press the PLAY▶ Push-button.

Note: To momentarily stop playback press either the Pause || Push-button or the STOP■ Push-button once. To resume Program Playback press the PLAY▶ Push-button.

5. To cancel the Program Playback Mode press the STOP■ Push-button twice followed by pressing the PGM (Program) Push-button.

DVD-Audio Disc Program Playback Mode

This feature allows for the playback of pre-selected Groups and/or Tracks of a DVD-Audio Disc in the desired order. Refer to figure 79.

Notes: 1. The MVP871 must be in full STOP Mode (two presses of the STOP Push-button) with the Disc Table of

Contents (TOC)

read before the Program Playback Mode Feature can be activated.

2. If a DVD-Audio disc has both

formats (DVD-Audio and DVD-Music Video), only the DVD-Audio Groups/Tracks are programmable.

DVD-AUDIO PROGRAM	
SELECT GROUP	GROUP TRACK
GROUP 1	1
GROUP 2	2
GROUP 3	3
GROUP 4	4
GROUP 5	5
GROUP 6	6
	7
	8
	9
	10

PRESS PLAY TO START CLEAR ALL

Figure 79

1. Press the PGM (Program) Push-button to access the On-Screen Program Mode.
2. Use the the Up▲ or Down▼ directional Push-buttons to select the first desired Group followed by the SELECT Push-button. Use the the Up▲ or Down▼ directional Push-buttons to select the first desired Track of the previous selected Group.

Note: The MVP871 automatically stores into memory each of the program steps as they are entered.

3. In a similar manner, add any additional Groups/Tracks.

Note: To remove a given Group/Track Program Step use the Right▶ Push-button followed by the Up▲ or Down▼ directional Push-buttons to select the Program Step to be removed. Then press the CLEAR Push-button to delete it.

4. To start playback of the just entered program press the PLAY▶ Push-button.

Note: To momentarily stop playback press either the Pause || Push-button or the STOP■ Push-button once. To resume Program Playback press the PLAY▶ Push-button.

5. To cancel the Program Playback Mode press the STOP■ Push-button twice followed by pressing the PGM (Program) Push-button.

Reset of Microprocessors

In the unlikely event the controls of the MVP871 stop functioning, the microprocessors can be reset by performing the following:

1. Press and hold in the STANDBY/ON Push-button until the STANDBY/ON LED is no longer illuminated. Then release the STANDBY/ON Push-button.

Note: This can be performed with the MVP871 On or in the Standby Mode.

2. The MVP871 will automatically switch On and normal operation will resume.

MP3/WMA Audio CD, JPEG Photo CDs, Video CD and DivX DVD Playback

The MVP871 has the ability of playing back special types of disc formats that are created primarily on a computer. The ability to successfully playback these discs on the MVP871 Player is dependent upon using the correct hardware and software. Please refer to the maker of the computer and software publisher to insure proper results.

The MP3/WMA Audio CD Formats allow the placing of more tracks on a CD Disc by using the technique of lossy compression applied to the original audio information. A special version of WMA allows for lossless version of the original audio information. The MP3 Track after compression is applied, results in lower audio quality than the original recording.

The JPEG Photo File Format is used by a majority of Digital Photo Cameras on the market and the Photos are easily viewed on a variety of consumer products. Some of the Kodak¹ Picture CDs and Fujifilm² Fujicolor² CDs may also playback on the MVP871.

The Video CDs allow for the playback of “Live Video” copied from devices such as Camcorders and some Digital Cameras.

The DivX DVDs allow for playback of movies/videos downloaded via the internet and recorded onto a DVD recordable disc.

MP3/WMA Audio Playback

The MVP871 will display the Folder Structure and Tracks from a CD Disc with MP3 format to make the song selection process easier. To play a MP3 disc perform the following steps:

1. Load a MP3/WMA Disc into the MVP871, about 5 to 20 seconds later a Disc Information On-screen Icon will appear on the Monitor/TV indicating the Folder/Tracks Organization of the Disc. Refer to figures 80 and 81.

2. Use the Right▶ or Left◀ / Up▲ or Down▼ directional Push-buttons to highlight the desired Folder or Track followed by pressing the SELECT

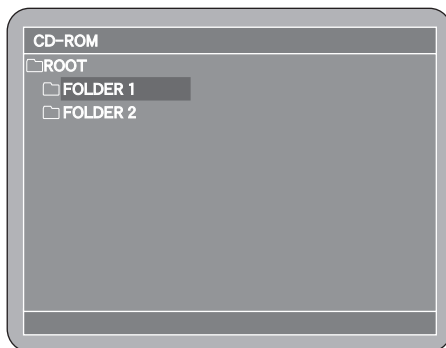

Figure 80

the folder, then push the SELECT Push-button. The selected Track will now start playing.

Note: The Column on the left side of the

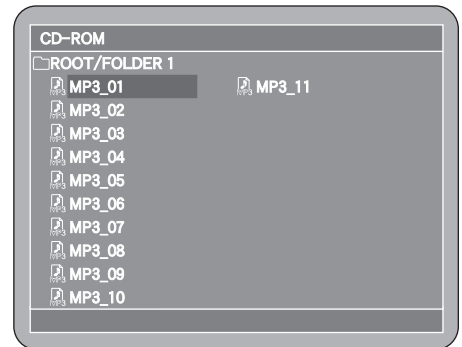

Figure 81

Disc Information On-screen Icon indicates any folders on the Disc. The right side column indicates Tracks located in the open Folder. The basic transport functions such as Next, Back, Fast-Forward, Reverse, Stop, Pause, Play and Random Playback continue to function as normal. The Next and Back Push-buttons will select Tracks within the current folder. To play Tracks in other Folders use the direction push-buttons to select the desired folder first.

JPEG Photo CDs

The MVP871 will display the Folder Structure and Photos from a CD Disc with JPEG file format. To view a JPEG Photo disc perform the following steps:

1. Load a JPEG Disc into the MVP871, about 5 to 20 seconds later a Disc Information On-screen Icon will appear on the Monitor/TV indicating the Folder/Photo Organization of the Disc.
2. Use the Right▶ or Left◀ / Up▲ or Down▼ directional Push-buttons to highlight the desired Folder or Photo followed by the pressing the SELECT Push-button. If a Folder was selected, use the directional push-buttons to select the desired Photo within the folder, then push the SELECT Push-button. The selected Photo will appear now.

Notes: The column on the left side of the Disc Information On-screen Icon indicates any folders on the Disc. The right side column indicates Photos located in the open Folder. The basic transport functions such as Next, Back, Stop, Pause and Play continue to function as normal. The Next and Back Push-buttons will select Photos within the current folder. To view Photos in other Folders use the direction push-buttons to select the desired folder first.

¹“Kodak” is a trademark of Eastman Kodak Company.

²“Fujifilm” and “Fujicolor” are trademarks of the Fuji Company.

How to Operate the MVP871, con't

Video CDs

To start playback of the Video CD Disc perform the following steps:

1. Load a Video CD Disc into the MVP871, about 5 to 20 seconds later a Disc Menu On-screen Icon will appear on the Monitor/TV indicating the available choices for playback.
2. Use the Right▶ or Left◀ / Up▲ or Down▼ directional Push-buttons to highlight the desired Video followed by pressing the SELECT Push-button. The selected Video will start playing.

Notes: The basic transport functions such as Fast-Forward, Reverse, Stop, Pause and Play continue to function as normal.

DivX DVD Discs

To start playback of the DivX Video Disc perform the following steps:

1. Load a Video CD Disc into the MVP871, about 5 to 20 seconds later a Disc Menu On-screen Icon will appear on the Monitor/TV indicating the available choices for playback. Refer to figure 82.

2. Use the Right▶ or Left◀ / Up▲ or Down▼ directional Push-buttons to highlight the desired Video followed by pressing the SELECT Push-button. The selected Video will start playing.

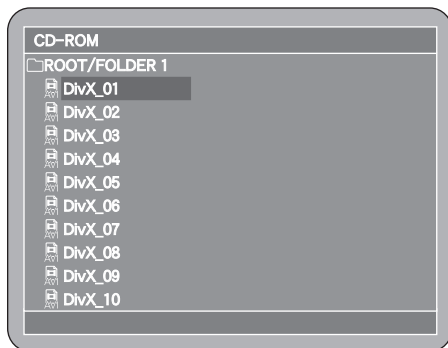
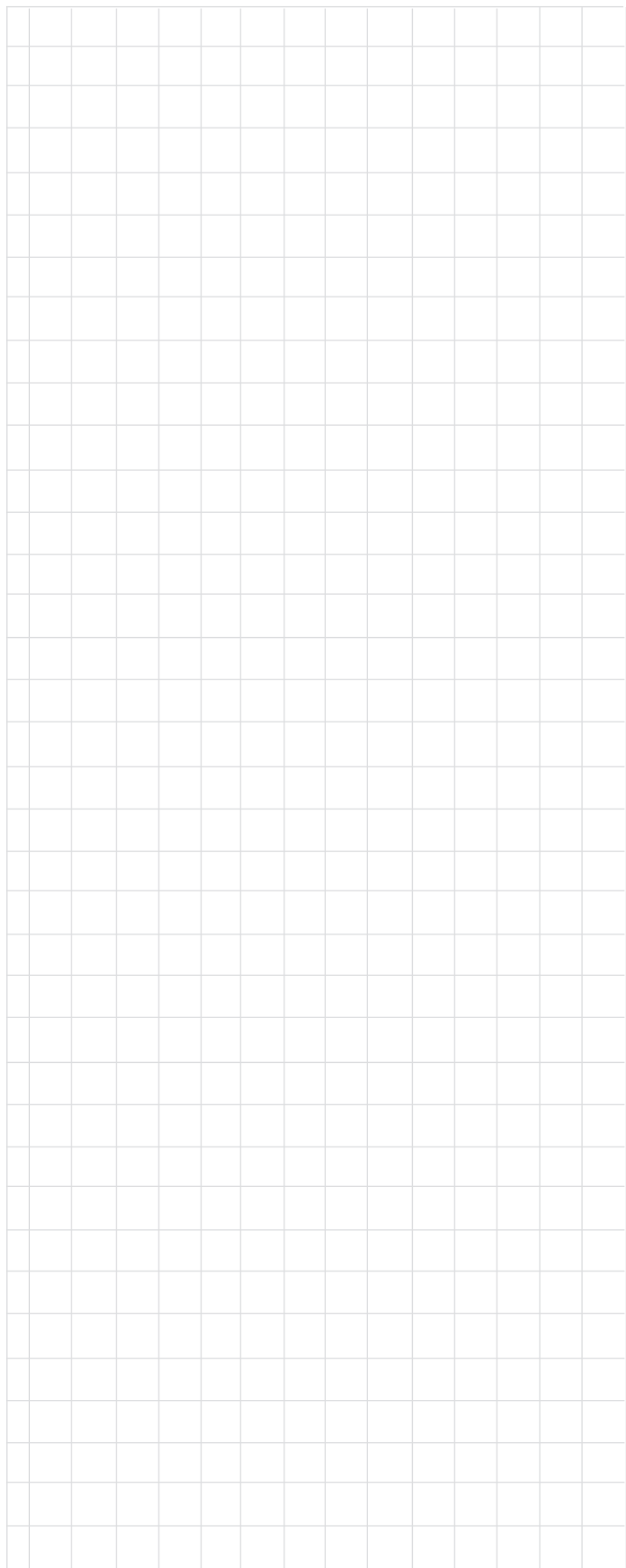

Figure 82

Notes: The basic transport functions such as Fast-Forward, Reverse, Stop, Pause and Play continue to function as normal.



MVP871 Video Settings and Adjustments

HDMI Settings

The MVP871 HDMI Digital Video Settings allow for matching the requirements of a wide variety of TV/Monitor types in use today. These include CRT, DLP, LCD and Plasma TV/Monitors, each with different Aspect Ratios and native resolutions.

For TV/Monitors with Digital Video Input(s) the MVP871 HDMI Video Output Signal will provide the best possible image quality. The HDMI SELECT and HDMI FORMAT Push-buttons on the Front Panel of the MVP871 or the HDMI SEL/INTRO and HDMI FMT/INPUT Push-buttons on the Remote Control, allow for matching the exact Digital Video requirements. Refer to figures 83 and 84.

The HDMI SELECT Push-button switches the HDMI Video Signal On and Off and allows the selection of different types of video signals:

Video Signal	Description
Y, C _B , C _R	Component Format Video Signal
RGB	Red, Blue and Green (RGB) Video Signal
PC Res	Computer RGB Video Signal at 60Hz

The HDMI FORMAT Push-Button allows the selection of different video signal resolutions:

Video Signal	Available Resolutions
Y, C _B , C _R	480/576i, 480/576p, 720p, 1080i, 1080p and AUTO
RGB	480/576i, 480/576p, 720p, 1080i, 1080p and AUTO
PC Res	VGA, XGA, WXGA, SXGA

Always refer to the TV/Monitor Owner's Manual for information on the correct video signal format and resolution when setting the MVP871 HDMI Output as this will provide the best possible image quality. In the event the information is not available, set the MVP871 HDMI Format to AUTO.

Note: When the MVP871 HDMI Output is active the video signal at the Component Video Output will automatically switch to the Interlaced Mode even though the word "Progressive" is illuminated on the Front Panel Information Display.

Video Adjustments

A MVP871 option allows the adjustment of various video parameters, not unlike the adjustments on a TV/Monitor. These custom adjustments can be stored into one of five memory locations. To enter custom settings perform the following steps:

1. Press the PIC ADJ (Picture Adjustment) Push-button to access the On Screen Icon. Refer to figure 84 and figure 85 on the next page.
2. Press the Right directional Push-button to select the "M1" Memory Location, followed by pressing the SELECT Push-button to

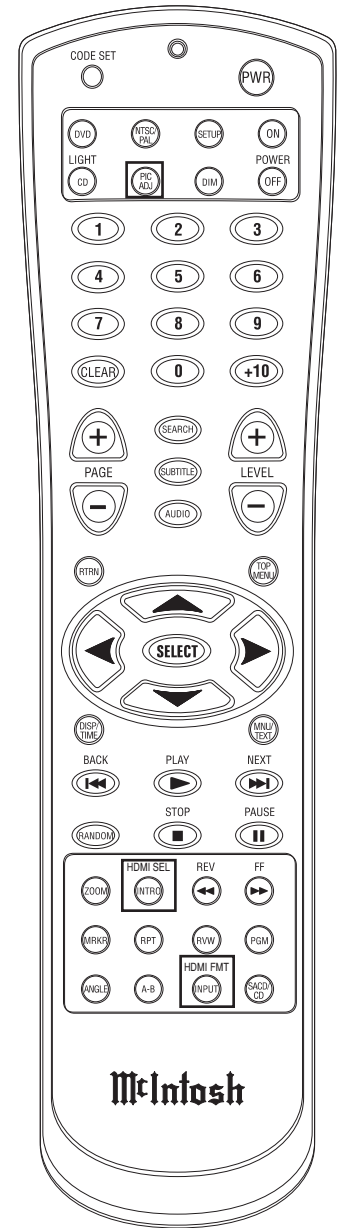

Figure 84

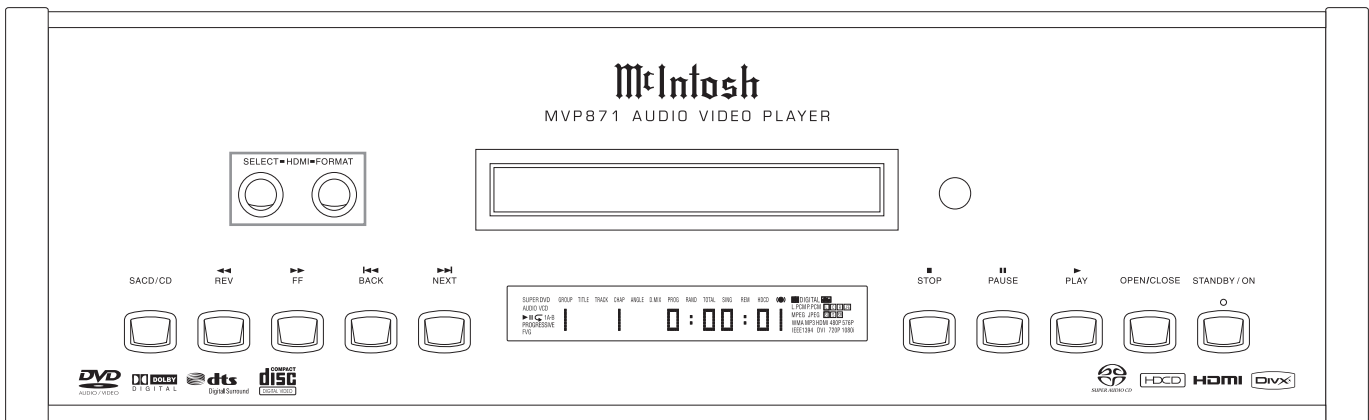

Figure 83

MVP871 Video Settings and Adjustments, con't

access the Memory 1 Picture Adjust 1 Settings. Refer to figure 86.

3. Press the Down▼ directional Push-button to activate the Picture Contrast Setting; use the Up▲ or Down▼ directional Push-buttons to adjust the Contrast from a setting of -6 to +6.



Figure 85



Figure 86

4. Press the Right▶ directional Push-button to select the Picture Brightness Setting. Use the Up▲ or Down▼ directional Push-buttons to adjust the Brightness from a setting of 0 to +12.
5. Press the Right▶ directional Push-button to select the Picture Sharpness (Mid) which effects the range of medium frequencies in the Video Signal. Use the Up▲ or Down▼ directional Push-buttons to adjust the Sharpness from a setting of -6 to +6.

Note: The Sharpness (Mid) is not active for the HDMI Outputs only.

6. Press the Right▶ directional Push-button to select the Picture Sharpness (Hi) which effects the range of high frequencies in the Video Signal. Use the Up▲ or Down▼ directional Push-buttons to adjust the Sharpness from a setting of -6 to +6.

Note: The Sharpness (Hi) is active for the Component Video Outputs with the Progressive Scan Mode active and HDMI Outputs.

7. Press the Right▶ directional Push-button to select the Picture Hue (Tint) Setting. Use the Up▲ or Down▼ directional Push-buttons to adjust the Hue from a setting of -6 to +6.

Note: The Hue Setting is not active for the Component Video Output with the Interlaced Mode active.

To exit the Memory 1 Adjust 1 Mode press the SELECT Push-button. To make additional video adjustments, use the Right▶ directional Push-button to select Memory 1 Adjust 2 and press the SELECT Push-button. If no other adjustments are to be made at this time, exit by pressing PIC ADJ Push-button. Refer to figure 87.

8. Press the Down▼ directional Push-button to activate the Picture White Level Setting; use the Up▲ or Down▼



Figure 87

- directional Push-buttons to adjust the brightness of White Areas of the image from a setting of -5 to +5.
9. Press the Right▶ directional Push-button to select the Picture Black Level Setting. Use the Up▲ or Down▼ directional Push-buttons to adjust the darkness of the colors in the dark areas of the image from a setting of -5 to +5.

Note: The Black Level adjustment is active for the Component Video Outputs with the Progressive Scan Mode active and HDMI Outputs.

10. Press the Right▶ directional Push-button to select the Chroma Level Setting. Use the Up▲ or Down▼ directional Push-buttons to adjust the intensity of the Colors in the image from a setting of -6 to +6.
11. Press the Right▶ directional Push-button to select the Enhancer Setting. Use the Up▲ or Down▼ directional Push-buttons to adjust contours of the image from a setting of -0 to +11.

Note: The Enhancer adjustment is active for the Component Video Outputs with the Progressive Scan Mode active and HDMI Outputs.

To exit the Memory 1 Adjust 2 Mode press the SELECT Push-button. To make additional video adjustments, use the Right▶ directional Push-button to select Memory 1 Adjust 3 and press the SELECT Push-button. If no other adjustments are to be made at this time, exit by pressing PIC ADJ Push-button. Refer to figure 88

12. Press the Down▼ directional Push-button to activate the Dynamic Noise Reduction (DNR) Setting; use the Up▲ or Down▼ directional Push-buttons to adjust the reduction of noise in the image from a setting of 0 to +3.

13. Press the Right▶ directional Push-button to select the Moving Pictures Experts Group (MPEG)



Figure 88

Noise Reduction (NR) Level Setting. Use the Up▲ or Down▼ directional Push-buttons to reduce noise of the contours around letter characters and other similar objects present in the image, the setting is ON or OFF.

14. Press the Right▶ directional Push-button to select the Setup Level. Use the Up▲ or Down▼ directional Push-buttons to adjust intensity of the Color Black in the image, the setting is 0IRE or 7.5IRE.
15. Press the Right▶ directional Push-button to select the Image's Horizontal Position on the screen. Use the Up▲ directional Push-button to shift the image to the right or use Down▼ directional Push-buttons to shift the image to the left, range of adjustment is -7 to +7.

Note: The Horizontal Position adjustment is active for the Component Video Outputs with the Progressive Scan Mode active and HDMI Outputs.

16. Press the Right▶ directional Push-button to select the Image's Vertical Position on the screen. Use the Up▲ directional Push-button to shift the image up or use Down▼ directional Push-buttons to shift the image down, range of adjustment is -7 to +7.

Note: The Vertical Position adjustment is active for the Component Video Outputs with the Progressive Scan Mode active and HDMI Outputs.

To exit the Memory 1 Adjust 3 Mode press the SELECT Push-button. To make additional video adjustments, use the Right▶ directional Push-button to select Memory 1 Adjust 4 and press the SELECT Push-button. If no other adjustments are to be made at this time, exit by pressing PIC ADJ Push-button. Refer to figure 89.

The last Picture Adjustment is known as Gamma Correction. This effects the linearity of "Gray Scale" values in an image. A Gray Scale consists of an image containing the color Black and the color White with different intensities of the color Gray, e.g. Black and White Movie. The Gamma Correction Adjustment in the MVP871 allows for very fine adjustment of 10 different segments in the "Gray Scale", one segment at a time. When these adjustments are

used sparingly, they can make a significant improvement in the appearance of the video image, over use can also have the opposite effect.



Figure 89

17. Press the SELECT Push-button to select the On-Screen Gamma Graph. Use the Right▶ or Left◀ directional Push-buttons to highlight the desired adjustment point on the Gamma Curve. Use the Up▲ or Down▼ directional Push-buttons to make fine adjustments to image. Press the SELECT Push-button to return to the Gamma Display. The values indicated are for each of the ten adjustment points on the Gamma Graph. Refer to figure 90.

When the desired adjustments are complete press the SELECT Push-button to exit the Gamma settings and press the PIC ADJ Push-button to exit the Picture Adjustments.



Figure 90

Note: The Picture Setting changes are stored in memory until new values are entered.



Audio Specifications

Number of Channels

2 and 5.1

Output Level

2.0Vrms Balanced (2 channel Output)

2.0Vrms Unbalanced (2 channel Output and 5.1 Channels)

Output Impedance

600 ohms Balanced (2 channel Output)

600 ohms Unbalanced (2 channel Output and 5.1 Channels)

Audio Frequency Response (DVD-Video)

4Hz to 22,000Hz (48kHz Sampling, Linear Audio)

4Hz to 44,000Hz (96kHz Sampling, Linear Audio)

Audio Frequency Response (DVD-Audio)

4Hz to 88,000Hz (192kHz Sampling)

SACD Frequency Response

4Hz to 100,000Hz

CD Frequency Response

4Hz to 20,000Hz

Signal to Noise Ratio

115dB

Dynamic Range

110dB

Harmonic Distortion

0.002%

Channel Separation

Better than 110dB (1,000Hz)

Video Specifications

Signal System

NTSC/PAL Region Code 1

Component Video Output Level

Y Output Level 1.0Vp-p (75 OHM)

P_B/C_B Output Level 0.648Vp-p (75 OHM)

P_R/C_R Output Level 0.7Vp-p (75 OHM)

S-Video Y Output Level

1Vp-p (75 OHM)

S-Video C Output Level

0.286Vp-p (75 OHM) (NTSC)

Composite Video Output Level

1Vp-p (75 OHM)

General Specifications

Digital Output

Optical: -15dbm to -21dbm

Coaxial: 0.5V p-p/75 ohm

Digital Signal Format

Sampling Frequencies: 44.1kHz, 48.0kHz, 96.0kHz and 192kHz

Transport

Laser Beam Wavelength: 630nm/810nm

Laser Power: CLASS I

Power Requirements

100 Volts, 50/60Hz at 60 watts

110 Volts, 50/60Hz at 60 watts

120 Volts, 50/60Hz at 60 watts

220 Volts, 50/60Hz at 60 watts

230 Volts, 50/60Hz at 60 watts

240 Volts, 50/60Hz at 60 watts

Note: Refer to the rear panel of the MVP871 for the correct voltage.

Overall Dimensions

Width is 17-1/2 inches (44.45cm)

Height is 6 inches (15.24cm)

Depth is 15-7/8 inches (40.32cm)

Note: When the Disc Tray is opened, the panel clearance required in front of mounting panel is 6-3/4 inches (17.2cm).

Weight

27.5 pounds (12.5Kg) net, 43.9 pounds (20.0Kg) in shipping carton

Shipping Carton Dimensions

Width is 26-1/2 inches (67.3cm)

Depth is 24-1/4 inches (62.2cm)

Height is 11-3/4 inches (29.9cm)

Packing Instructions

In the event it is necessary to repack the equipment for shipment, the equipment must be packed exactly as shown below. It is very important that the four plastic feet are attached to the bottom of the equipment. This will ensure the proper equipment location on the bottom pad. Failure to do this will result in shipping damage.

Use the original shipping carton and interior parts only if they are all in good serviceable condition. If a shipping carton or any of the interior part(s) are needed, please call or write Customer Service Department of McIntosh Laboratory. Refer to page 4. Please see the Part List for the correct part numbers.

Quantity	Part Number	Description
1	033838	Shipping carton only
4	033837	End cap
1	033836	Inside carton only
1	033725	Top pad
1	034301	Bottom pad
4	017937	Plastic foot
4	400159	#10-32 x 3/4" screw
4	404080	#10-7/16" Flat washer

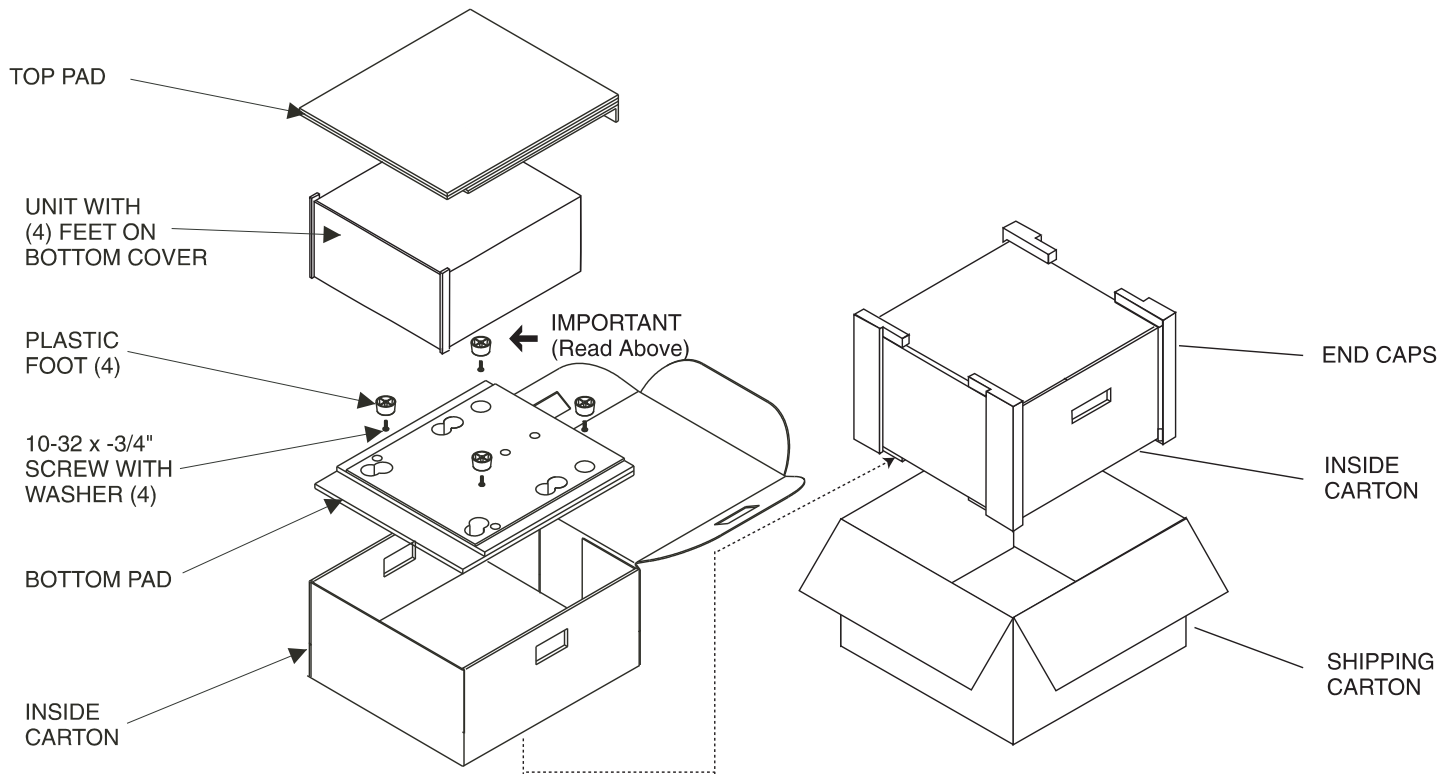



McIntosh Laboratory, Inc.
2 Chambers Street
Binghamton, NY 13903

The continuous improvement of its products is the policy of McIntosh Laboratory Incorporated who reserve the right to improve design without notice. Printed in the U.S.A.

McIntosh Part No. 04101801